

iD Inspiration

LUXURY VINYL TILES

Re-defining
authenticity

 **Tarkett**

Summary

4 Introduction

12 Design

16 Naturals

46 Authentics

56 Classics

66 Installation

68 Selection Guide

70 Glue-down

72 Click

74 Formats

76 Customisation

**82 General
Characteristics**

Dare to Inspire

In a rapidly changing world, we collectively have an opportunity to rethink and reinvent the way we live and transform our indoor spaces to promote healthier living. We have imagined iD Inspiration for this new world. As our flagship modular vinyl collection, it builds on a ten-year journey to continuously improve the user experience. Through our Tarkett Human-Conscious Design® approach, we develop flooring that helps people flourish in their every day without compromising on health and the environment. iD Inspiration exemplifies this approach, delivering enhanced modularity that enables agile transformation of space to meet the evolving demands of work and life. Meanwhile, its nature-inspired colours and themes – heightened by the ultra-realism of digital printing – help to achieve feel-good interiors.



Harnessing the Power of Nature

The new iD Inspiration sets an unprecedented milestone in the design of modular vinyl collections. Our advanced digital printing technology enables us to reveal the most subtle details of wood and stone to make each plank or tile unique in grain, texture and colour. Most importantly, it enables specifiers to choose the best of natural designs embedded in the highest-performing vinyl materials.

Capturing the beauty of wood and stone

“With this collection, our passionate design team have sought to pay tribute to nature while creating a highly realistic look and feel, combining natural colours and a faithful reflection of every detail.”

Florian Bougault - Art Director EMEA

Nature guides every aspect of our design journey. We have taken our design sourcing process to the next level, carefully making selections based on character, detail and natural diversity of expression. Every design in the Naturals collection is scanned directly from a chosen specimen of wood or stone, from oak to marble. By paying attention to the origins of these natural materials, we share with you the wonder of natural imperfections and nuances. The variety of our designs gives you the freedom to subtly match the style that best suits your space.

Bringing the outdoors inside

Designing spaces has moved definitively towards connecting interiors with the outdoor world, echoing the beauty of nature to improve quality of life in urban spaces. By selecting the best natural tones of woods and expressive stones, we have sought to bring the outdoors in.

In this way, we aim to create positive emotions to help enhance learning, working and caring. iD Inspiration decors were selected to foster a feel-good atmosphere, and bring interior designs to life through the use of our exclusive digital printing technology.

From the calm and peaceful pureness of blond oaks to the expressive darkness of traditionally charred Japanese woods, or raw sun-weathered boards, we sought a range of tree species such as elm, hornbeam, and walnut, to propose alternative wood grain patterns and colour variations, as well as new exclusive subtle textures such as MDF and Terrazzo.

Meanwhile, we have continued to focus on modularity and flexibility, with the introduction of oversize formats. The end result is a palette of designs, echoing authentic building materials, that enables you to create people-friendly spaces.



Human-Conscious Design

Tarkett Human-Conscious Design® is our pledge to stand with present and future generations. To create flooring and sports surfaces that are good for people and for the planet. And to do it every day. Developing a circular economy, innovating with good materials and exceeding indoor air quality standards are essential parts of our commitment for today's and future generations.

Indoor air quality

Our commitment to giving you healthier spaces to live and work is not just talk. By driving down VOC emissions, our products exceed the strictest industry standards for air quality by so much, we've had to set our own standards. Standards that we can prove with science, not just words.

Ultra-low VOCs



With 90% of time spent indoors, clear air matters. Our iD Inspiration collection showcases ultra low VOC emissions, less than 10µg/m³*.

*TVOC after 28 days.

Water-based inks



At Tarkett, we use water-based printing inks with no organic solvents through all our printing processes. This contributes to iD Inspiration's ultra low VOCs emissions. We are the only flooring manufacturer to use water-based inks with our digital printer.

Good materials

At Tarkett, we demand to know every detail about the materials we use. It's why we're obsessed with the health and sustainability standards of Cradle to Cradle® – a methodology that guides our good material choices. Complete transparency from us, peace of mind for you.

Made in Europe



Our iD Inspiration collection is manufactured in-house at our European production sites in Clervaux (Luxembourg) and Jaslo (Poland).

Phthalate-free



Our iD Inspiration collection is phthalate-free. It contributes to healthier spaces and helps you reach green building certifications like BREEAM, WELL and LEED.

Radical transparency

98% of our materials are independently assessed by EPEA.

Unique in the market, our MHS (Material Health Statements) give you a clear view of the health profile of the materials used in our flooring. Our EPDs share information on the materials' environmental impacts.

Circular economy

We are passionate advocates of the circular economy. It's why we're working to maximise the recycled content in all our products and prioritise end-of-life recycling. Preserving natural resources, reducing waste and carbon emissions and helping make your sustainable choices hassle-free.

Recycled content

40.7%

Our glue-down designs contain up to 40.7% recycled content*.

*38.80% production waste and 1.9% post-consumer waste.

Our ReStart® take-back and recycling programme



iD Inspiration is ReStart-ready. All post-installation off-cuts are recyclable at our recycling centre at Clervaux (Luxembourg). Post-consumer recycling is possible for click designs. We collected more than 105,000 tonnes of flooring through ReStart® from 2010 to 2019*.

*All collections combined in Europe, Brazil and North America.

Climate change

12% of the total volume of our purchased raw materials were recycled, avoiding 270,000 tonnes of CO₂ in 2019*.

*Estimation for part of scope 3.

**iD Inspiration
was elaborately
designed
to make your
flooring creation
process easy.**

100

Decors

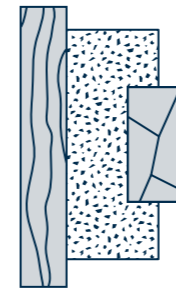

Naturals
Authentics
Classics

3

**Wear
layers**

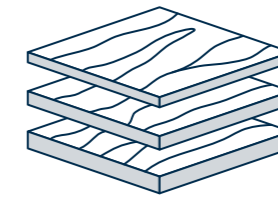

0.30 - Class 23/31
0.55 - Class 23/33/42
0.70 - Class 23/34/43

2

**Installation
methods**

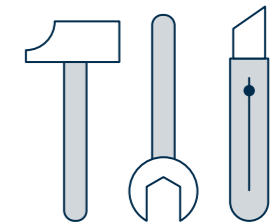

Glue-down
Click

3

**Printing
technologies**

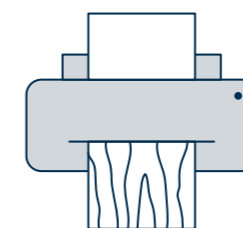

Digital printing
Embossing in register
Rotogravure

2

**Customisation
services**

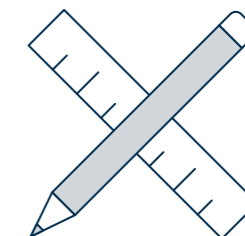

Pre-defined service
A la carte service

Design

100 decors are available with our new Tektanium™ PU coating, combining ultra matt finish with excellent resistance and durability properties.

1

Installation

All our designs are available in glue-down. We've preselected some designs for click installation, please consult the chart on pages 96.

2

Formats

With iD Inspiration, enhanced modularity is made more accessible with 7 standard formats to allow agile transformation of space.

3

Customisation

If you wish to make your project extra special, you can create an exclusive customised flooring with our designers at the Tarkett design lab.

4

Design

TEKTANIUM™

Best ultra matt finish and unequalled resistance

The iD Inspiration collection features our new TEKTANIUM™ PU coating which uses a proprietary polymer system - forming a naturally clear, verifiably stronger layer of protection that delivers unequalled resistance to scratches, abrasions, wear and stains. Moreover, it offers a pure ultra matt finish, which is consistently visible from all angles. By mixing ultra matt effect with excellent resistance and durability properties, the surface of your flooring appears more realistic and lasts longer. TEKTANIUM™ is the only PU coating to combine all these features, so there's no need for compromise.

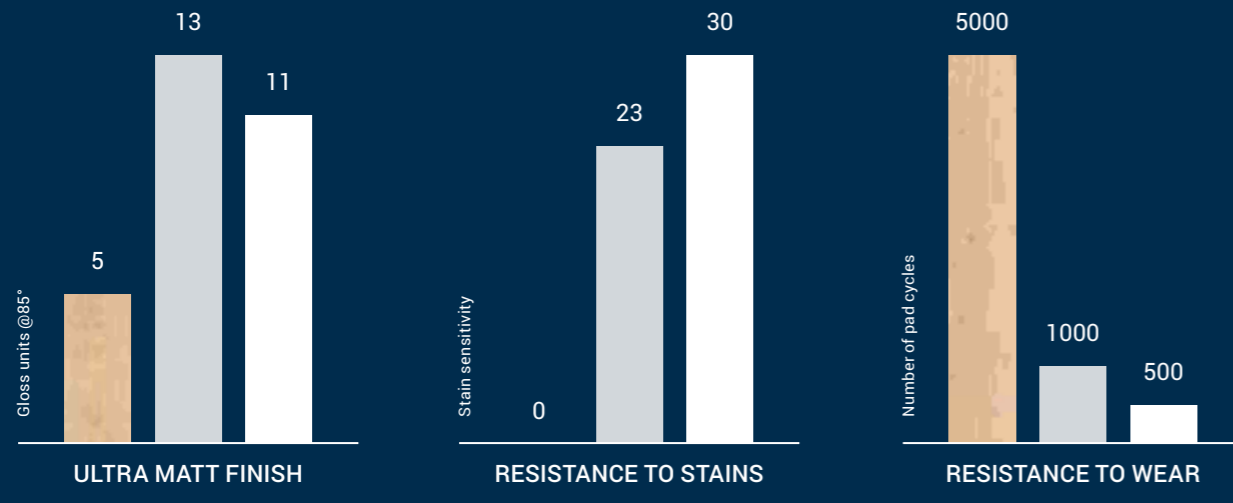

Gloss measurement at an 85° angle based on Tarkett's internal tests. (in compliance with ISO 2813)

< 6 = Ultra matt
> 10 = Satin

Stain resistance measurement based on Tarkett's internal tests (in compliance with ISO 26987).

0 = not affected (Best in class)
30 = very affected

Wear resistance measurement based on Tarkett's internal tests. (based on EN ISO 16094)

5000 = best in class

- Tarkett: iD Inspiration
- Key European competitor A
- Key European competitor B

NATURALS

Digital printing

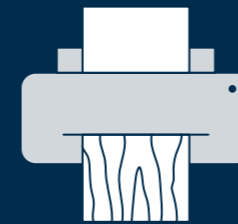

Scanned from nature through the meticulous sourcing of high quality raw materials, our Naturals designs display a high definition with non-repeating motifs for up to 12m².

Naturals decors are only available in glue-down, a selection will be available in click by the end of 2021.

AUTHENTICS

Embossing in register



This technology engraves effects onto planks and tiles. The embossed pores perfectly echo the high definition printed image, resulting in finishes that are evermore realistic.

Authentics decors are available in both glue-down and click.

CLASSICS

Rotogravure

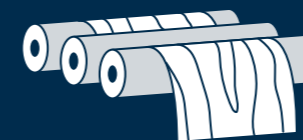

Classic gravure printing showcases our most acclaimed materials and colour harmonies.

Classics decors are available in both glue-down and click.

Naturals

Designing as nature intended

Our Naturals designs are scanned from nature through the meticulous sourcing of high quality raw materials such as wood and stone. Using a unique patent-protected digital printing technology, the only single-pass 2m wide printer for jetting water-based inks on vinyl in the world, we have reflected the best of nature's diverse features, from characterful wood grains to the subtle textures and nuances of stone. To convey the true diversity of the natural world in all its glory, our modular vinyl flooring displays a high definition with non-repeating motifs for up to 12m² (2x6m) and an ultra matt finish.

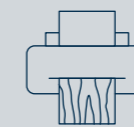

**HIGH
DEFINITION**



**2x6m
NO REPEAT**



**BIGFOOT
FORMAT**

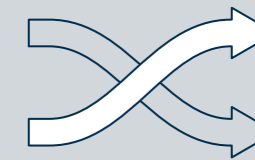

No Repeat

12m²

TARKETT NATURALS

No repeat up to 50 planks
120cmx20cm format

Our Naturals designs display
a high definition with non-repeating
motifs up to 12m² (2x6m).

3m²

STANDARD LVT : 3m²

No repeat up to 10 planks
120cmx20cm format

Mix materials
creatively
in an open
concept design

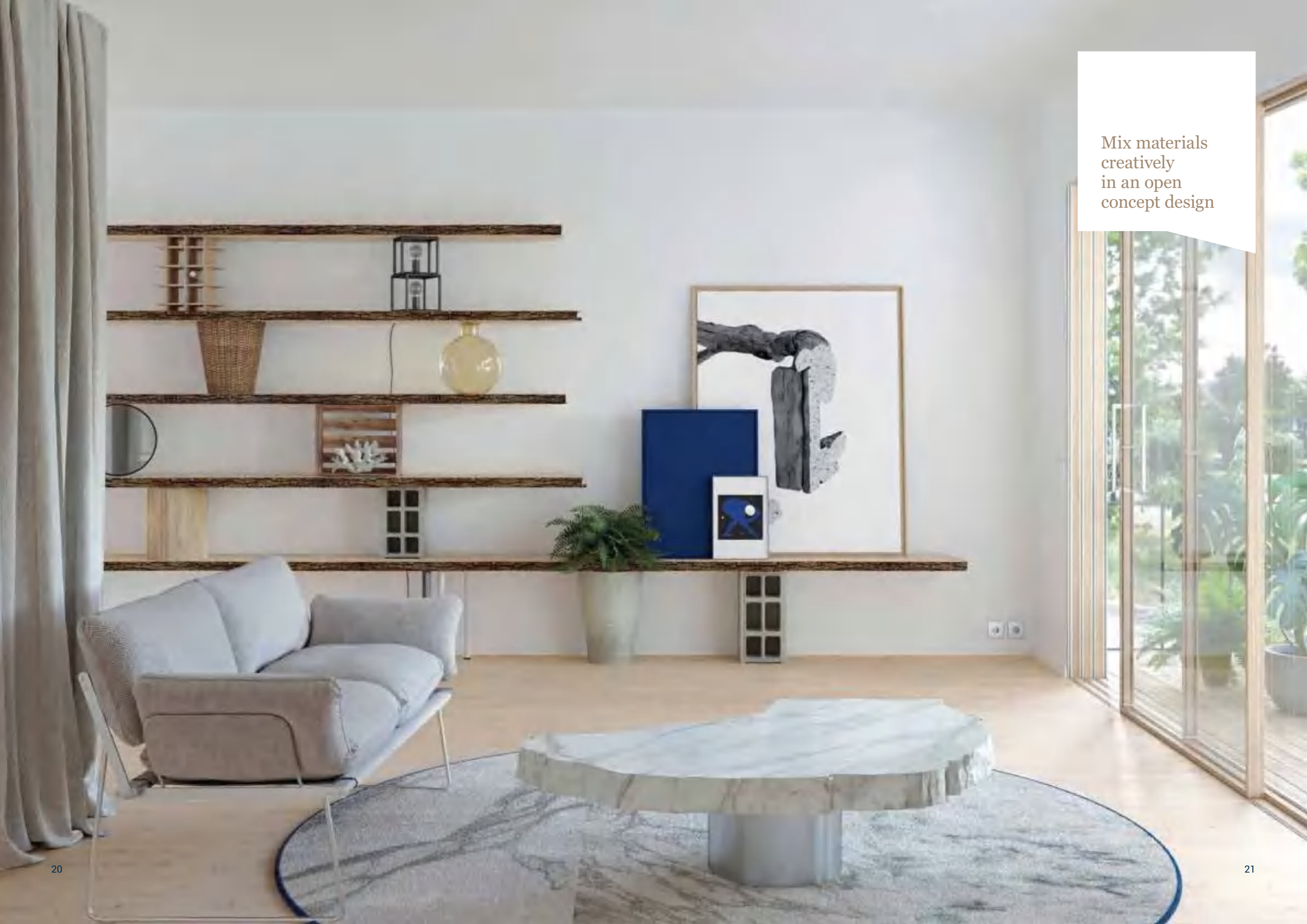



Desso Sense of Marble AA81 - 1103
Terrazzo Classical Nero - glue-down 0.30 - 24532 079
Nomad Oak Linen - glue-down 0.30 - 24526 069



Add a touch of colour to brighten your space

Saintonge

MICRO		VERDELLI PASTA	14
DAINT PLAN	14	BARBERS	10
TONA CERCHI	16	TONA CERCHI	11
BARBER BART	14	SEVENTE	
COLD BROWN	16	INDICTION	8
BARBER SALAD	12	PANNA CHEESE	8

WAS NOT 30



Terrazzo Classical Terracotta - glue-down 0.55 - 24521 080
 Fibra Terracotta - glue-down 0.55 - 24522 084
 Brushed Elm Grege - glue-down 0.55 - 24515 055
 Century Dawn - glue-down 0.55 - 24523 059



Let flooring
be your guide
for clear,
flowing lines





Desso Futurity - 9960
Patina Concrete Light Grey - glue-down 0.70 - 24511 032
Douglas Pine Creme - glue-down 0.70 - 24503 045
American Walnut Cinnamon - glue-down 0.70 - 24502 051





Make the most of natural light with the right flooring

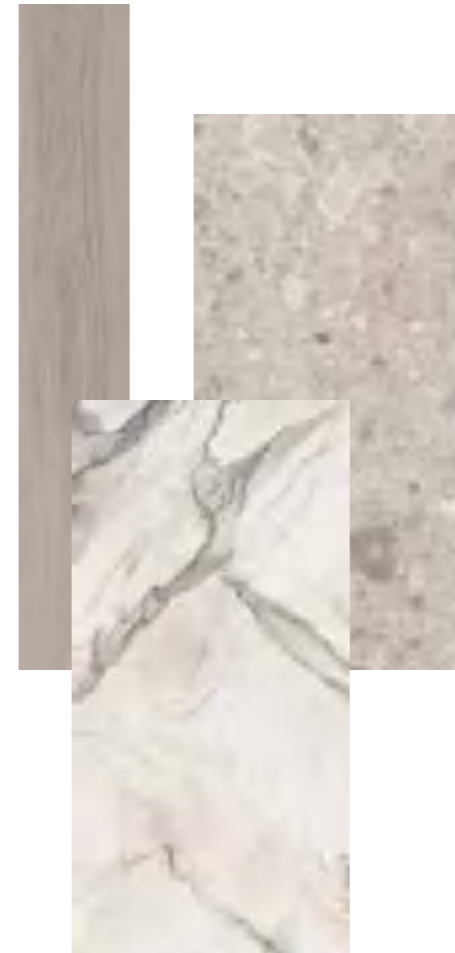
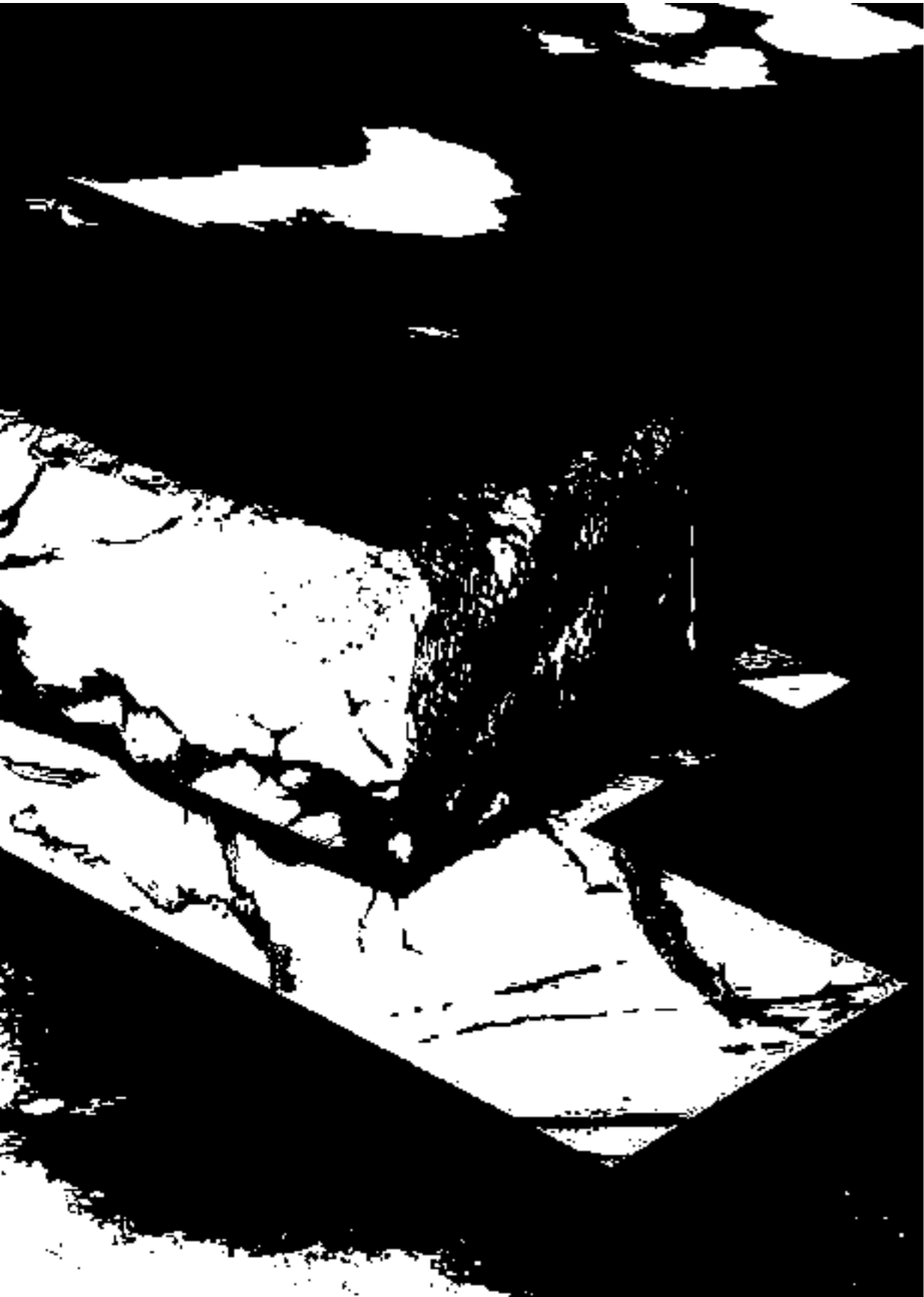

Breccia Grey - glue-down 0.70 - 24511 052
Variant Oak Light Grey - glue-down 0.70 - 24502 039
Carrara Grande White - glue-down 0.70 - 24511 044

Colour Chart

- 1 Variant Oak
- 2 Creek Oak
- 3 Forest Oak
- 4 Classic Pine
- 5 Swiss Oak
- 6 Nomad Oak
- 7 Charred Wood
- 8 American Walnut
- 9 Fibra
- 10 Brushed Elm
- 11 Chatillon Oak
- 12 Wagon Board
- 13 Chestnut
- 14 Douglas Pine
- 15 Patina Concrete
- 16 Belgian Stone
- 17 Travertin Grande
- 18 Marquina Grande
- 19 Carrara Grande
- 20 Breccia
- 21 Cast Concrete
- 22 Emperador
- 23 Sediment
- 24 Century
- 25 Moonstone
- 26 Liguria Slate
- 27 Terrazzo Classical



Variant Oak

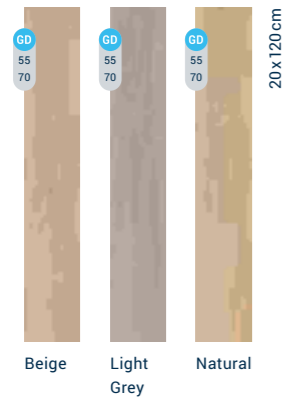

Creek Oak

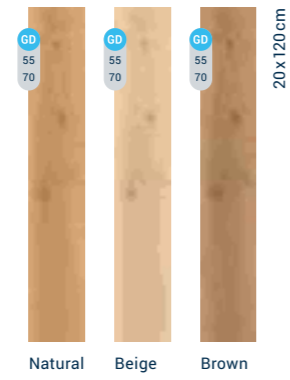

Forest Oak

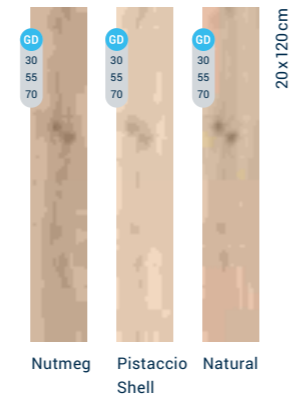

Classic Pine

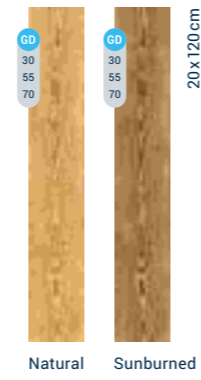

Patina Concrete



Belgian Stone



Swiss Oak



Nomad Oak



Charred Wood



American Walnut



Travertin Grande



Marquina Grande

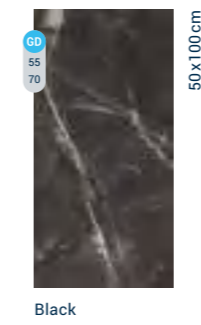

Carrara Grande

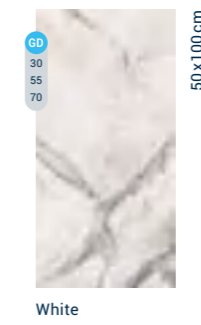

Breccia

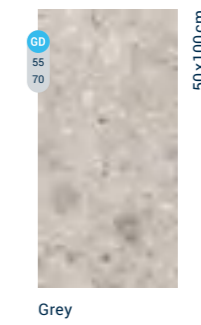

Cast Concrete



Fibra



Brushed Elm

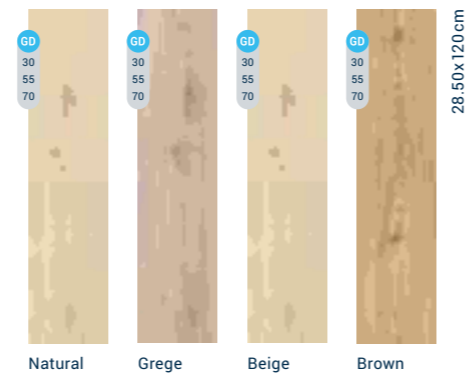

Emperador

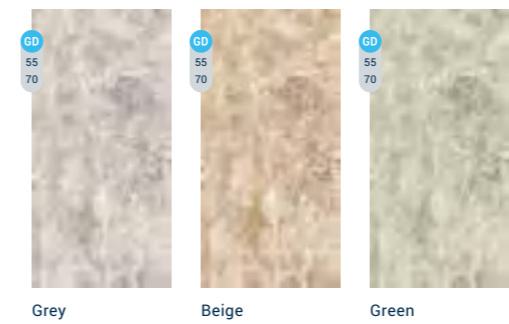

Sediment



Chatillon Oak

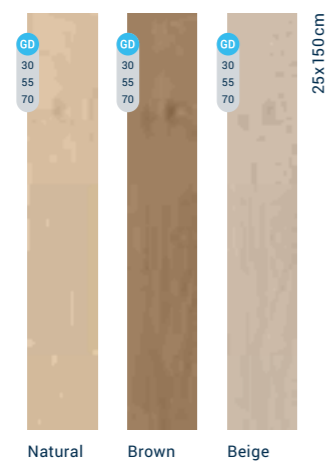

Wagon Board



Chestnut

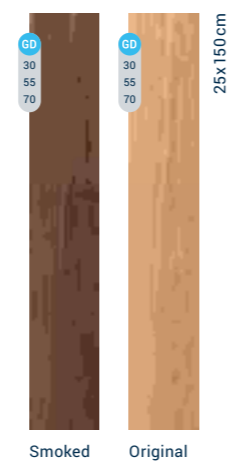

Douglas Pine



Century



Moonstone

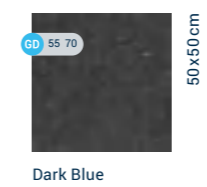

Liguria Slate

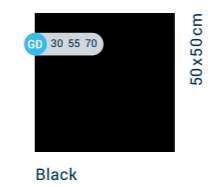

Terrazzo Classical



GD Glue-down: Available on stock
30 0.30: Available on stock
55 0.55: Available on stock
70 0.70: Available on stock

C Click: A selection of decors will be available on stock by end of 2021

More of Naturals



Charred Wood Black - glue-down 0.55 - 24513 053
Marquina Grande Black - glue-down 0.55 - 24522 068



Belgian Stone Dune - glue-down 0.70 - 24511 036

Sediment Grey - glue-down 0.55 - 24523 074
Chestnut Original - glue-down 0.55 - 24514 064

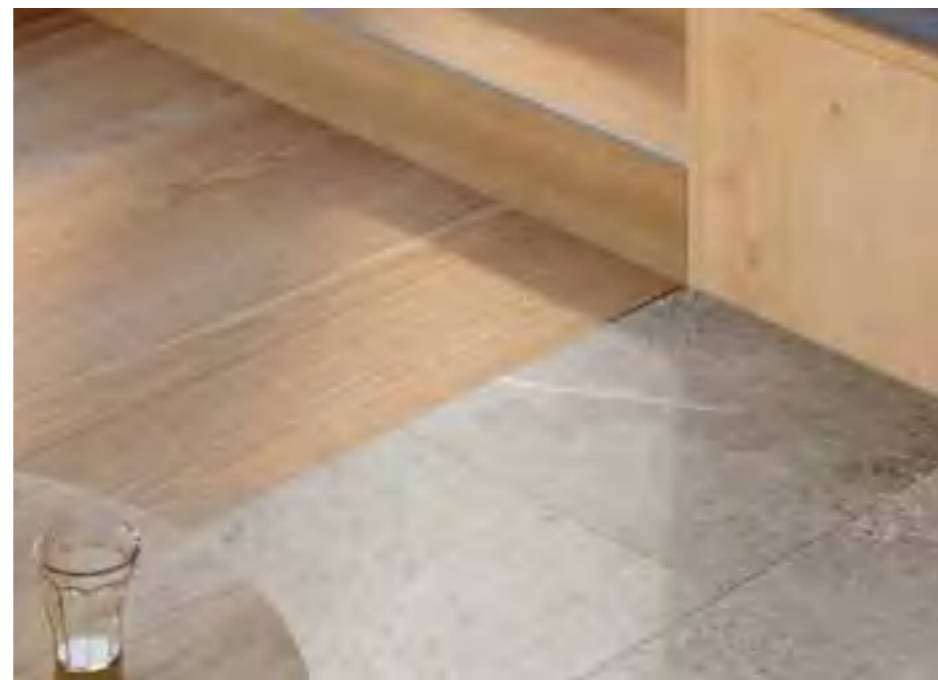

Chatillon Oak Brown - glue-down 0.55 - 24514 061

Swiss Oak Smoked - glue-down 0.30 - 24526 076
Cast Concrete Cement - glue-down 0.30 - Make to order

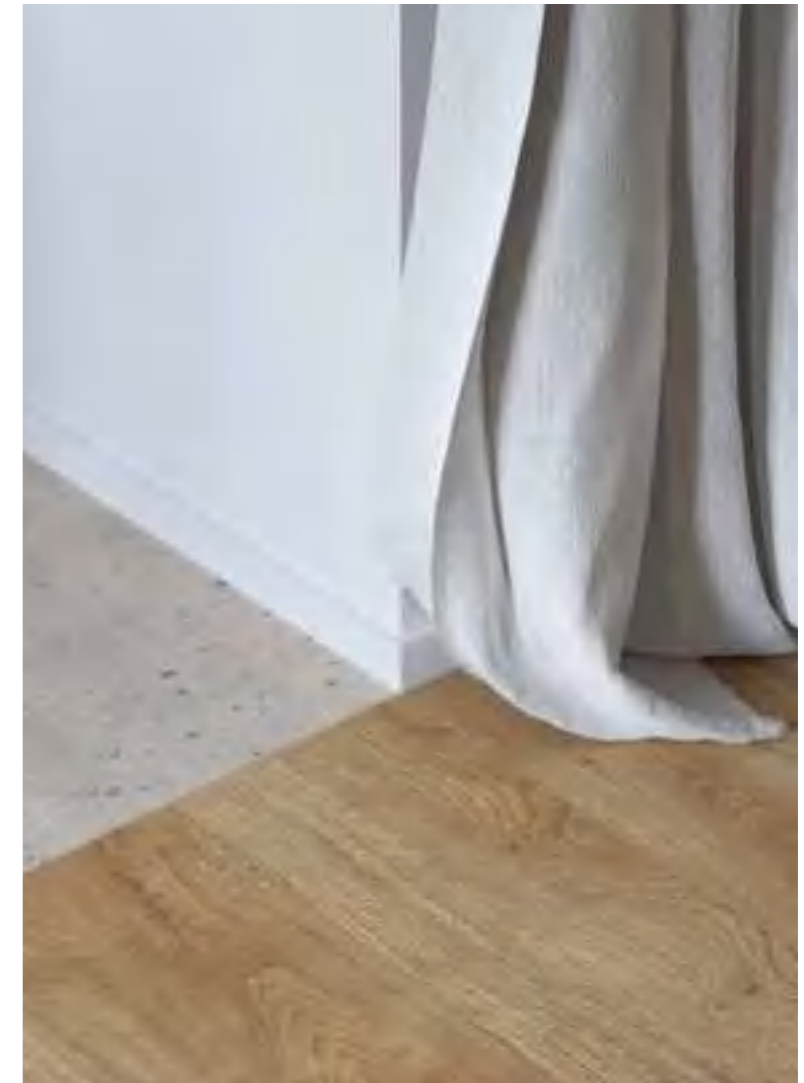



Moonstone Dark Blue - glue-down 0.55 - Make to order (format change)

Wagon Board Floated - glue-down 0.55 - 24514 081



Travertin Grande Sand - glue-down 0.55 - 24517 082

Liguria Slate Black - glue-down 0.70 - 24507 067
Creek Oak Beige - glue-down 0.70 - 24502 041

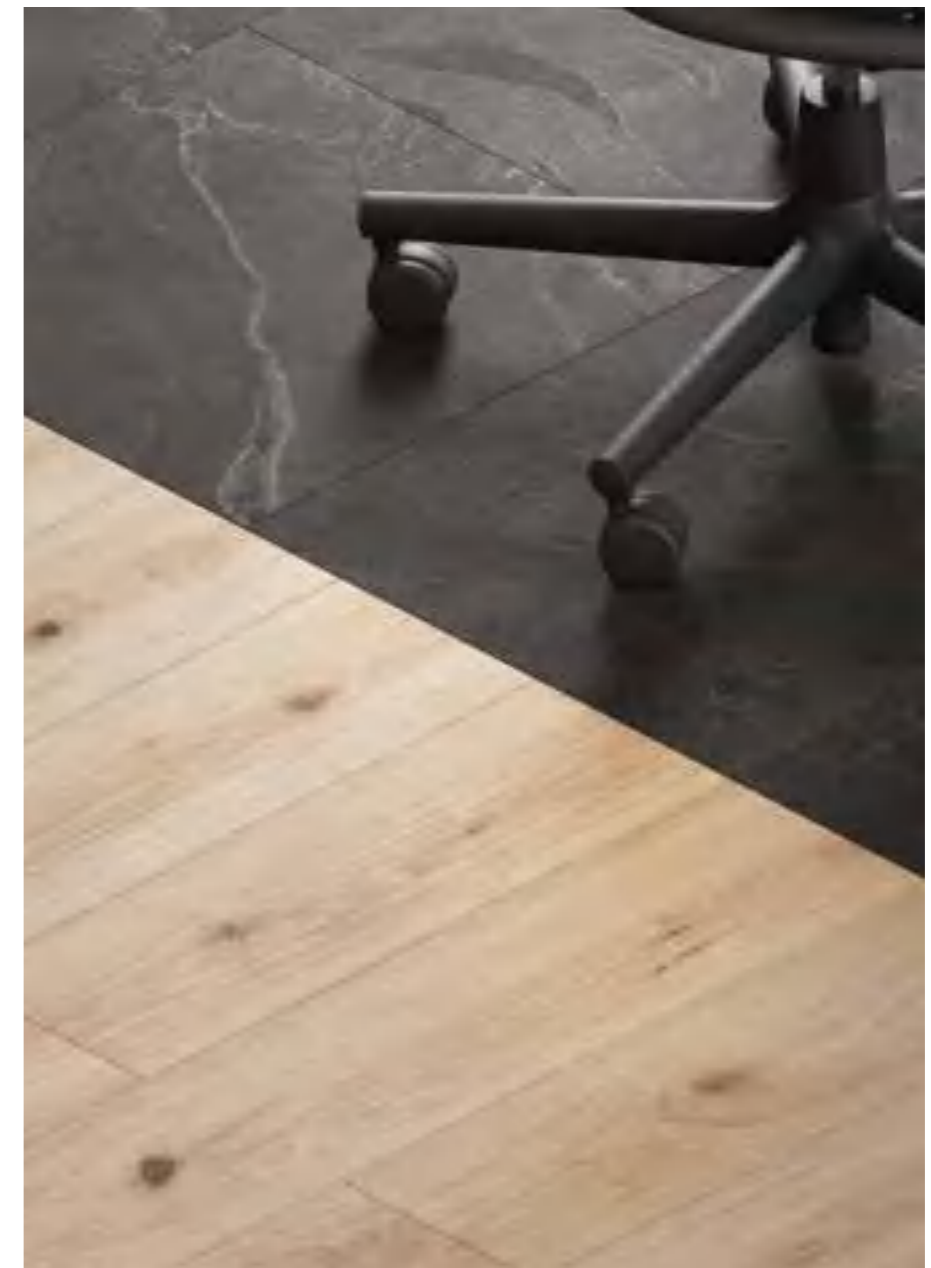

Authentic

Synchronising look and feel

Our Authentics designs are created with "Embossing in register" technology for a more natural look. This technology engraves effects onto planks and tiles to reproduce unique flooring that gives a truly realistic impression of real wood. The embossed pores perfectly echo the high definition printed image, resulting in finishes that are ever-more realistic, increasingly authentic and precise.



**14 DIFFERENT
COLOURS**



**REALISTIC
IMPRESSION**



**3 NEW
DESIGNS**



Make a statement with contrasting colour hues

- ▣ Auditorium
- ▣ Library
- ▣ Workshop

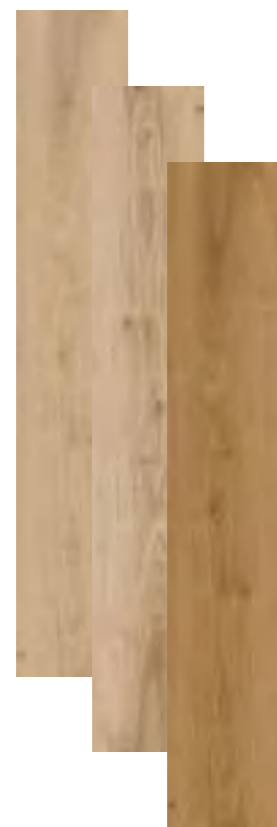

Delicate Oak Almond - glue-down 0.55 - 24513 092
Delicate Oak Barley - glue-down 0.55 - 24513 094
Delicate Oak Toffee - glue-down 0.55 - 24513 093





Colour Chart

- 1 Pearl Oak
- 2 Highland Oak
- 3 Delicate Oak

1

2

3

Pearl Oak

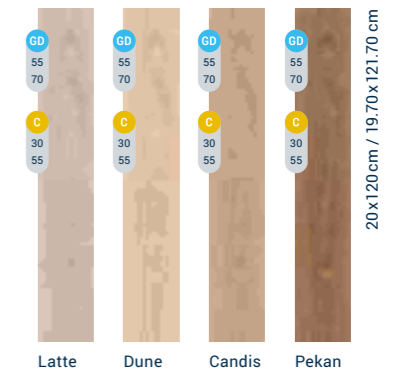

Highland Oak

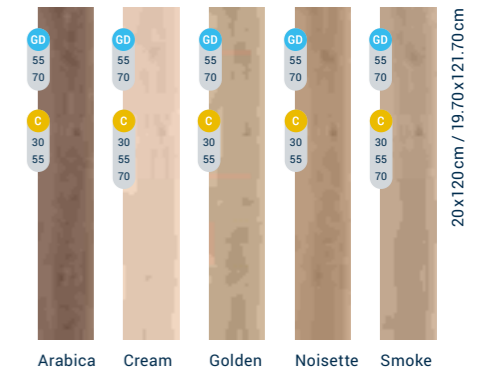

Delicate Oak

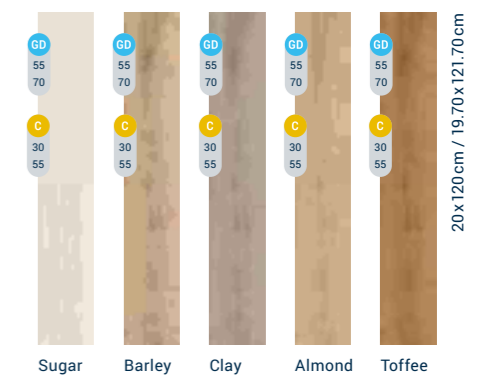

- GD Glue-down: Available on stock
- C Click: Available on stock
- 30 0.30: Available on stock
- 55 0.55: Available on stock
- 70 0.70: Available on stock

The designs and photos used in this brochure are for illustration purposes only. They are not contractual images and do not stand for product or installation recommendation.

More of Authentics

Pearl Oak Pekan - glue-down 0.55 - 24513 098



Highland Oak Arabica - click 0.55 - 24616 088

Classics

Trusting in our origins

Classic gravure printing has stood the test of time for decades. For this collection, our designers have selected our most acclaimed materials and colour harmonies to help you develop feel-good interiors. Our new Tektanium™ PU coating reinforcement achieves ultra matt effect and brings warmth and realism to the flooring's look and feel, while ensuring stain resistance and easy cleaning. Enhanced modularity is made more accessible to allow agile transformations of space.

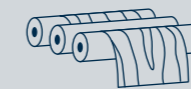

ROTOGRAVURE

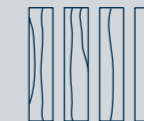

11 BEST IN
CLASS DESIGNS

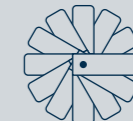

28 COLOURS

Pair chic dark walls and floors for a gorgeous blend of refinement



Colour Chart

- 1 English Oak
- 2 Contemporary Oak
- 3 Rustic Oak
- 4 Scandinavian Oak
- 5 Antik Oak
- 6 Brushed Pine
- 7 Patina Ash
- 8 Composite
- 9 Rock
- 10 Vintage Zinc
- 11 Oxide



English Oak



Contemporary Oak

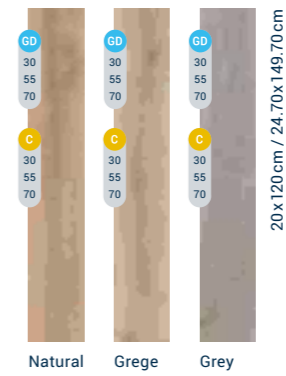

Rustic Oak

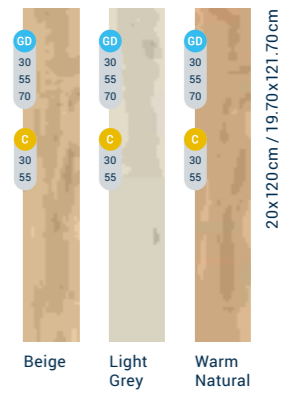

Scandinavian Oak

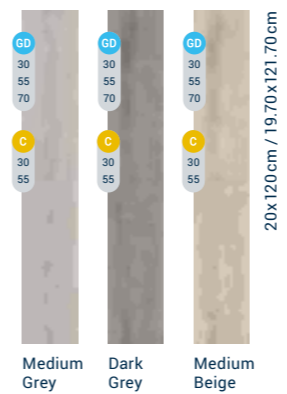

Antik Oak

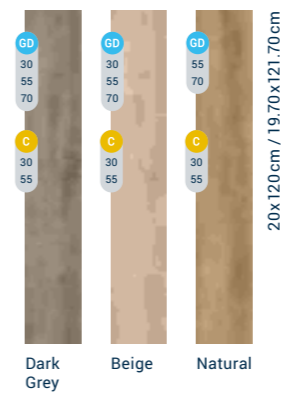

Brushed Pine

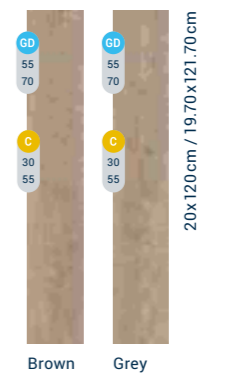

Patina Ash

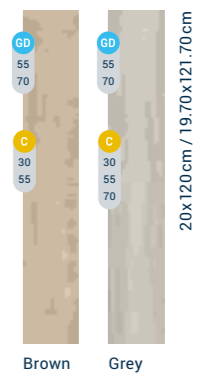

Composite

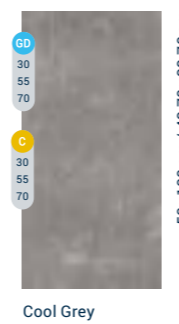

Rock



Vintage Zinc

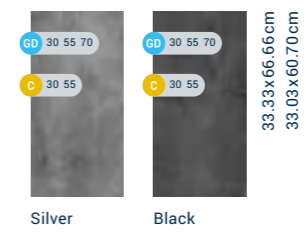

Oxide



GD Glue-down: Available on stock
 C Click: Available on stock

30 0.30: Available on stock
 55 0.55: Available on stock
 70 0.70: Available on stock

More of Classics



Patina Ash Grey - glue-down 0.55 - 24513 017
Rustic Oak Light Grey - glue-down 0.55 - 24513 026
Contemporary Oak Grey - glue-down 0.55 - 24513 021

Brushed Pine Grey - glue-down 0.55 - 24513 005
Oxide Black Steel - glue-down 0.55 - Make to order (format change)



Composite Cool Grey - glue-down 0.55 - Make to order (format change)

Rock Grey - glue-down 0.70 - 24505 001
English Oak Brown - glue-down 0.70 - 24502 009



Installation

Whether you're designing hotels, shops, restaurants, offices, public spaces or collective housing, iD Inspiration provides a flexible, high quality solution. Taking into account your requirements in terms of footfall, resistance, acoustic comfort, and rapidity of installation, all the while ensuring a realistic, natural appearance, we will assist you in choosing the flooring that best suits your project.

Glue-down

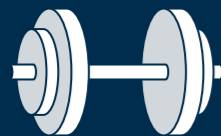

Maximum durability



Infinite layouts



Extreme resistance

More about glue-down: p.70
More about click: p.72

Click



Improved performance



Fast and reliable click system



Good dimensional stability

Selection Guide

iD Inspiration offers you the opportunity to tailor your flooring to best meet your project's requirements. You can put together the best combination of design, wear layer, installation and format.

0.30

Moderate traffic

0.55

High traffic

0.70

Very high traffic

Residential

Retail

Restaurant

Hotel

Education

Workplace

Public Spaces

GLUE-DOWN



- Durability
- Wide choice of layouts
- Cost



- Durability
- Wide choice of layouts
- Cost



- Durability
- Wide choice of layouts



- Durability
- Wide choice of layouts



- Durability
- Wide choice of layouts
- Cost



- Durability
- Wide choice of layouts
- High resistance even in very high traffic areas



- High resistance even in very high traffic areas
- Best option for large areas

CLICK



- Easy renovation
- Less subfloor preparation
- Less waiting time (no glue)



- Easy renovation
- Direct installation over existing flooring*



- Easy renovation
- Acoustic solution (installed with acoustic foam)
- Reduction of business downtime



- Easy renovation
- Acoustic solution (installed with acoustic foam)
- Reduction of business downtime



- Easy renovation
- Acoustic solution (installed with acoustic foam)
- Reduction of business downtime



- Easy renovation
- Acoustic solution (installed with acoustic foam)
- High resistance even in very high traffic areas



- Easy renovation
- Less subfloor preparation
- Less waiting time (no glue)
- Profiles required

*Place directly over existing flooring and ceramic tiles with tight joints (see installation notice).

●● Primary recommendation

● Secondary recommendation

Glue-down

Benefit from a worry-free and long-lasting installation

Our glue-down designs are suitable for residential and commercial areas ranging from moderate to very high traffic environments. Our new proprietary Tektanium™ coats to an attractive ultra matt finish, which allows maximum light on your flooring, brings warmth and enhances realism. Made in Europe, iD Inspiration carries a 10-year limited warranty for commercial use and 15-year limited warranty for residential use.

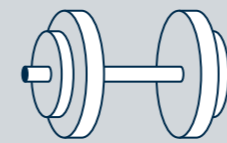

Maximum durability

Vinyl has many qualities that make it a great choice for durable flooring, glue-down vinyl even more so. It is a great option in high traffic areas and busy homes. It is easy to take care of, requiring little maintenance and no regular renovation.



Infinite layouts

From simple floor patterns to more elaborate compositions, you can easily mix and match multiple formats and colours to build your own iD Inspiration experience.



Extreme resistance

iD Inspiration has been designed for the most intense traffic areas. It withstands heavy loads and indentation, enabling maximum resistance to both static and rolling heavy loads up to 800kg*.

*800kg refers to our 0.70 wear layer references.

Click Solid Click High Traffic

Save time with our click system

Designed to allow quick and straightforward installation, iD Inspiration Click Solid is an ideal solution for demanding semi-commercial areas. Made in Europe, our angling/push-down system makes for a floating installation, requiring little subfloor preparation. Planks are clicked together rather than being stuck to the subfloor.



Fast and reliable click system

Our angling/push down locking system enhances technical performance and achieves more rapid and easier installation. Its high-locking strength ensures durability and stability for your installation. A rubber hammer is required on the short side only, making installation 35% faster* than glue-down products.

35% quicker* than
glue-down products

*Estimation based on Tarkett's internal tests.



Improved performance

We've reinforced the rigidity for our iD Inspiration Click Solid 30 and 55 designs, moving away from resilient to semi-rigid characteristics. The rigidification grants extra stability to our products and offers the possibility to place them directly over existing flooring and ceramic tiles with tight joints (see installation notice).

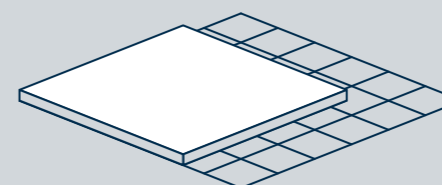

Good dimensional stability

Based on a double fibre glass reinforcement, our patented Fibertech technology achieves good dimensional stability and allows for installation in sun-exposed or with high temperature variation areas. Silicon finishes for waterproof installations are also possible. No expansion profiles are required for up to 150sqm.

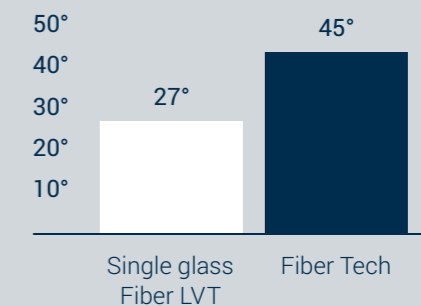

Maximum temperature of the floor allowed after installation (°C) based on Tarkett's internal tests.

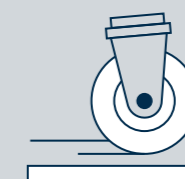

Suitable for high traffic areas

iD Inspiration Click High Traffic 70 is highly suited for use in very busy areas like public buildings or shopping centres. An exclusive patented reinforced core layer combines a rigid part, to bear heavy loads and indentation, and a flexible part to withstand mechanical constraints allowing the flooring to bear static and dynamic heavy loads up to 500kg*.

*See installation guide: installation is performed directly on a clean subfloor, with no underlay.

Formats

With iD Inspiration, enhanced modularity is made more accessible with 7 standard formats* to allow agile transformation of space.

3

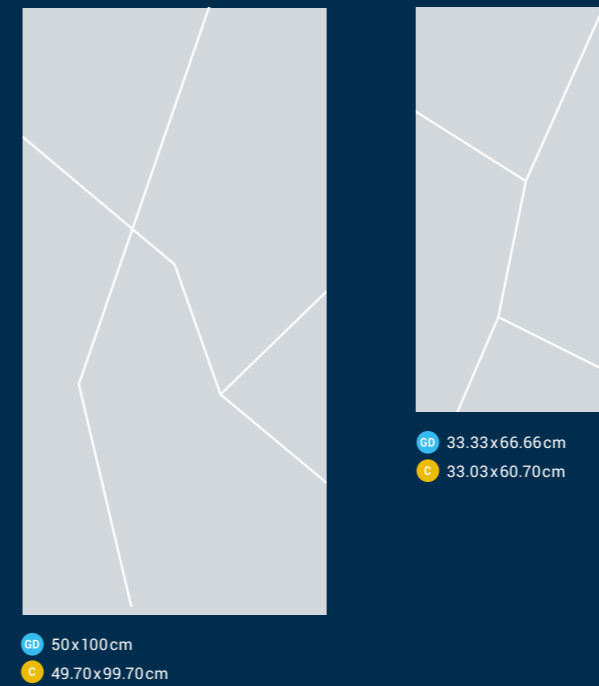

*Formats are specific per design.
Please go to customisation if your chosen format is not available as standard.

Customisation

The collection offers near endless combinations. Every aspect of the product is customisable with all decors.

1 PRE-DEFINED SERVICE

2 À LA CARTE SERVICE

- Select an existing format
- Choose a bevel
- Select an embossing
- Select a colour from the library
- Pick a design from the library

- Define a custom colour from NCS & RAL
- Request a new design



Customised designs are available on MTO (make to order). Please check with your sales representative for specific timing and customisation terms and conditions. All projects will have to be evaluated individually.



Select an existing format

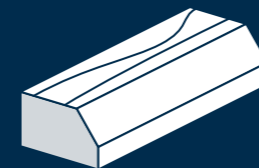

Choose a bevel



Select an embossing



Select a colour from the library or define a custom colour from NCS & RAL



Pick a design from the library



Request a new design

Create floors
like you've
never seen
before





Naturals - Fibra custom colour - glue-down 0.55
Naturals - Breccia custom design and colour - glue-down 0.55
Naturals - Classic Pine custom colour - glue-down 0.55
Naturals - Forest Oak Pistaccio Shell - glue-down 0.55 - 24513 030
Desso Avenue - 9096

General Characteristics

82 Accessories

- 84 General
- 86 Glue-down
- 88 Click

91 Specification model

92 Technical Datasheet

- 92 Glue-down
- 93 Click

94 Product Details and Skirtings

- 94 Glue-down
- 96 Click

Accessories

Skirting

SEMI-RIGID SKIRTING

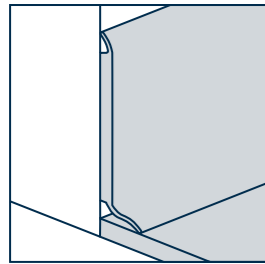

PVC semi-rigid skirting for decorative use with upper and lower soft lips.

Size (mm) KS61: 2500 lengthx15 thicknessx60 height
1 box of 20
Size (mm) KS80: 2500 lengthx15 thicknessx80 height
1 box of 20
Size (mm) KS100: 2500 lengthx15 thicknessx100 height
1 box of 20

Skirting KS 61 - 60 mm

- White 1411 002
- Aluminium 1411 051
- Black 1411 007
- Dark Grey 1411 008
- Medium grey 1411 009
- Grey 1411 010
- Light Grey 1411 011
- Concrete cool grey 1411 053
- Very Light grey 1411 012
- Light Beige 1411 027
- Oak long strip natural 1411 052
- Beige 1411 021
- Dark beige 1411 054
- Dark brown 1411 013
- Intense Plum 1411 049
- Rose wood 1411 032
- Grege 1411 026
- Medium beige 1411 025
- Bright Orange 1411 047
- Red 1411 019
- Bright yellow 1411 048
- Intense Olive 1411 050
- Green Yellow 1411 036

- Bright turquoise 1411 055
- Intense petrole 1411 056
- Green blue 1411 044
- Blue green 1411 035
- Sky blue 1411 042
- Medium blue 1411 041
- Dark blue 1411 039

Skirting KS 80 - 80 mm

- White 1411 257
- Concrete cool grey 1411 262
- Dark grey 1411 258
- Medium grey 1411 259
- Grey 1411 260
- Dark beige 1411 261

Skirting KS 100 - 100 mm

- White 1411 163
- Concrete cool grey 1411 168
- Dark grey 1411 164
- Medium grey 1411 165
- Grey 1411 166
- Dark beige 1411 167

DECORATIVE SET-ON SKIRTINGS

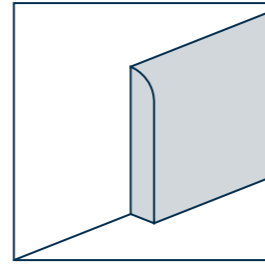

Compact PVC skirting with decorative film and PUR surface treatment to perfectly match selected designs.

Size (mm): 1950 lengthx10 thicknessx60 height
1 box of 5 (9.75lm)

For PVC skirtings matching the exact colour of our iD Inspiration designs, please refer to the product details and skirtings chart on pages 94 to 97.

RENOVATION SKIRTING

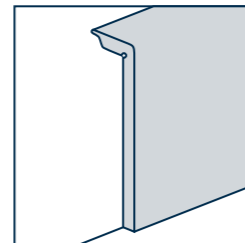

White high density polystyrene foam 100% recyclable with a protective varnish.

Size (mm): 2000 lengthx22 widthx110 height
1 box of 18 pieces (36lm)

- White 1411 301

General

Underlay

JUMPAX ORIGINAL®

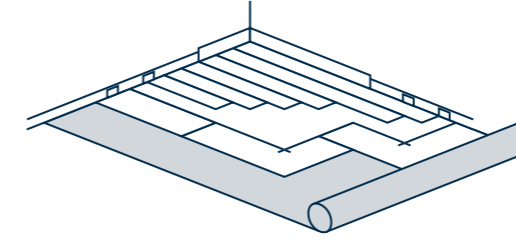

Prefabricated fast-track floor preparation system on MDF, with polystyrene foam covered with aluminium film.

Size (m): 1.20 lengthx0.60 width
4 base and 4 top boards (2.88m²)

- Beige 24993 010

TARKOPROTECT 180

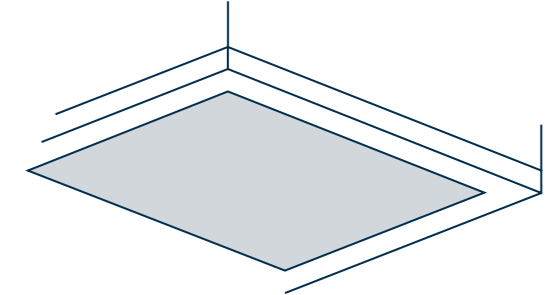

Self adhesive overlayer made of polyester veil for better floor protection.

Size (m): 50 lengthx1 width
24 rolls per pallet

- White 24990 000

Accessories

Accessibility

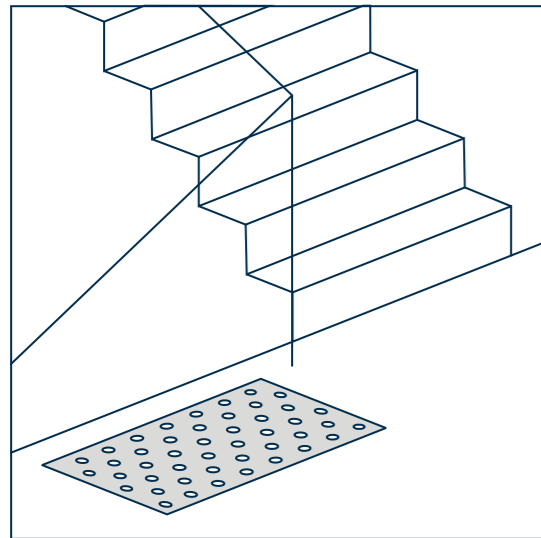

WARNING TILES SELF-ADHESIVE RECTANGULAR TILE

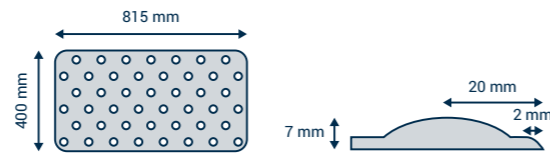

Polyurethane self-adhesive tile with studs that acts as a tactile warning for visually impaired people to alert them to a potential danger in staircases.

Size (mm): 400 width x 7.0 thickness x 815 length
1 box of 10 tiles

- White 1440 350
- Grey 1440 351
- Black 1440 352

WARNING TILES

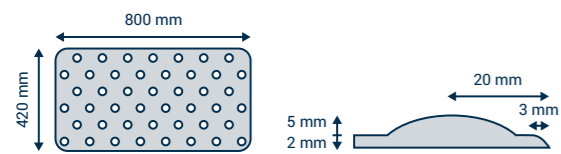

Rubber tile with studs that acts as a tactile warning for visually impaired people to alert them to a potential danger in staircases. To be glued.

Size (mm): 420 width x 7.0 thickness x 800 length
1 box of 6 tiles

- White 1431 001
- Black 1431 002
- Light Grey 1431 003

WARNING TILES SELF-ADHESIVE SQUARE TILE

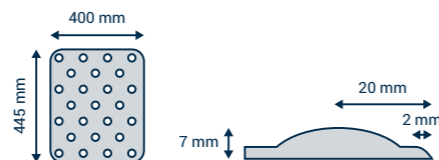

Polyurethane self-adhesive tile with studs that acts as a tactile warning for visually impaired people to alert them to a potential danger in staircases.

Size (mm): 400 width x 7.0 thickness x 445 length
1 box of 10 tiles

- White 1440 450
- Grey 1440 451
- Black 1440 452

Glue-down

TACTILE STRIP SELF-ADHESIVE LINEAR STRIP

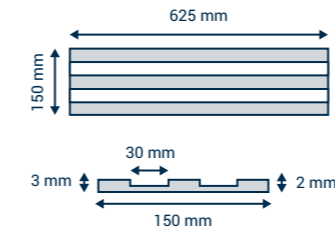

Polyurethane self-adhesive tactile strip guides for visually impaired people to help find their way. The linear strip helps their white walking stick follow the channel.

Size (mm): 150 width x 2.0 lower thickness x 3.0 upper thickness x 625 length
15 strips per box

- White 1440 250
- Grey 1440 251
- Black 1440 252

TACTILE STRIP SELF-ADHESIVE STRIP IN ROLLS

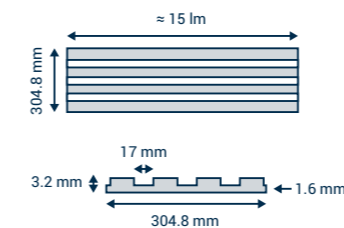

Polyurethane self-adhesive tactile strip guides for visually impaired people to help find their way.

Size (mm): 304.8 width x 1.6 lower thickness x 3.2 upper thickness x 15240 length
1 roll per box

- Snow White 1440 001
- Charcoal 1440 020
- Black 1440 040

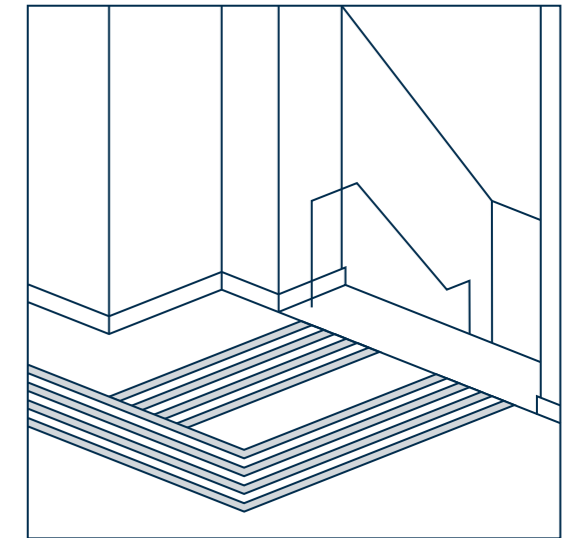

Underlay

TARKOMFORT SELF-ADHESIVE

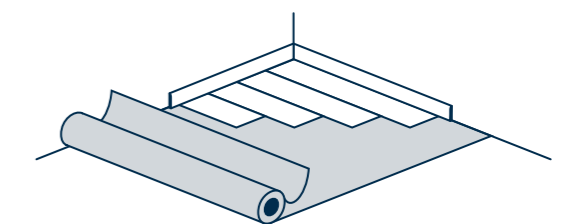

Self-adhesive underlayer made of mineral fillers and polyurethane binders to improve acoustic performance.

Size (m): 6.5 length x 1 width
40 rolls per pallet

- Black 24992 040

Accessories

Skirting

SKIRTING BOTTOM

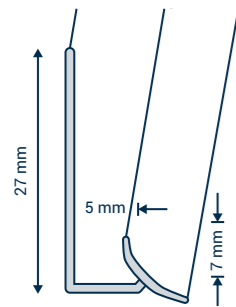

Aluminium skirting bottom to be combined with the cap for skirting. To be glued.

Size (mm): 2500 length x 5 inside x 7 lower lip x 27 height
10 units (25lm) per box

● Silver 26626 021 ● Stainless Steel 26626 022

LVT SKIRTING CAP

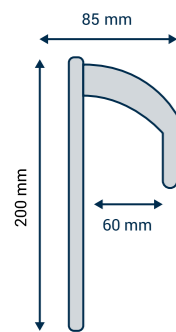

Aluminium skirting cap to be combined with skirting bottom in order to use floor covering on the wall as skirting. To be glued.

Size (mm): 2500 length x 6 width inside x 8.5 width outside x 20 height
10 units of 2.5lm in a cardboard box = 25lm

● Silver 26626 011 ● Stainless Steel 26626 012

Stair Nosings

STAIRNOSE HIGH TRAFFIC

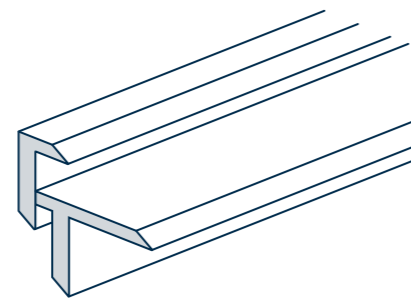

Aluminium stairnose to be screwed. Very resistant to wear and traffic. Ribbed surface for slip-resistance.

Size (mm): 40 width x 5 inside x 2500 length
Full kit including stairnose profile, screws and dowls.
10 units of 2.5lm per box = 25lm

● Silver 1434 021 ● Stainless Steel 1434 022

STAIRNOSE VERY HIGH TRAFFIC

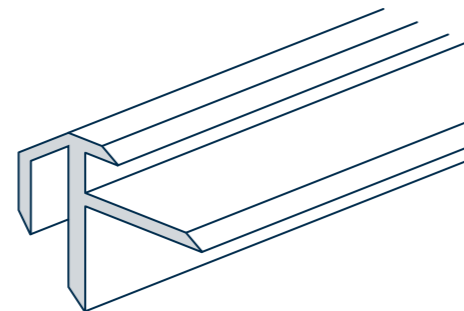

Aluminium stairnose used in high-traffic areas. To be screwed. Very resistant to very high traffic. Ribbed surface for slip-resistance

Size (mm): 30 height x 38 width x 5/5.5 thickness x 2500 length
Full kit including stairnose profiles, screws and dowls.
5 units of 2.5lm per box = 12.5lm

● Silver 1434 011 ● Stainless Steel 1434 012

Click

Profiles

TRANSITION PROFILE GENERAL TRAFFIC

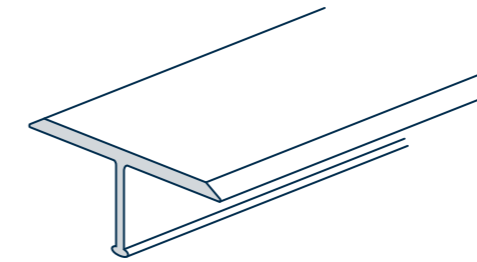

Aluminium transition strip for use in general traffic areas. To be screwed.

Size (mm): 2700 length x 24 width x 6 height.
10 units of 2.7lm per box

● Silver 1451 021 ● Stainless Steel 1451 022

TRANSITION PROFILE VERY HIGH TRAFFIC

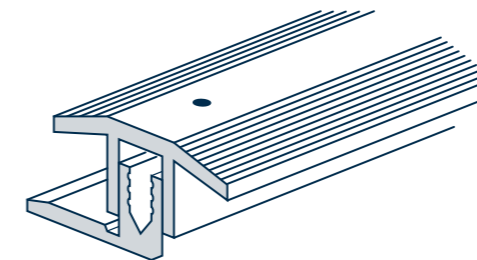

Aluminium transition strip in two parts for use in high-traffic areas. To be screwed.

Size (mm): 2700 length x 25 width x 4 height (down position)
2700 length x 25 width x 9.5 height (upper position)
10 units of 2.7lm per box

● Silver 1451 011 ● Stainless Steel 1451 012

BENDABLE STOP PROFILE

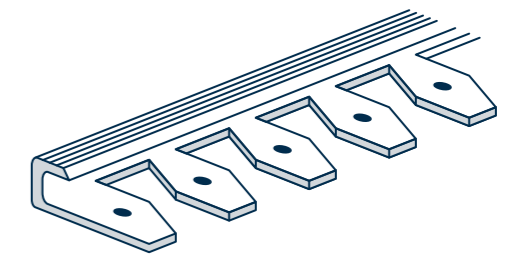

Aluminium bendable stop profile for high-traffic areas. To be screwed.

Size (mm): 2500 length x 30 width x 5 height inside x 8 height outside
10 units of 2.5lm per box

● Silver 1456 011 ● Stainless Steel 1456 012

RAMP PROFILE

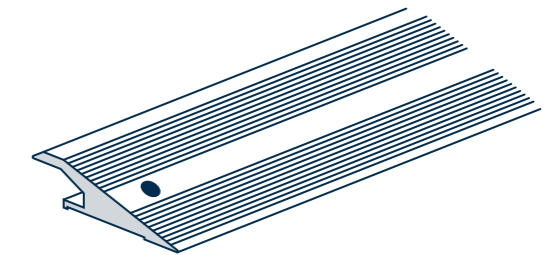

Aluminium ramp profile, used in heavy-traffic areas. To be screwed.

Size (mm): 2700 length x 38 width x 5 height
2700 length x 38 width x 7 height
10 units of 2.7lm per box

● Silver 1454 011 ● Stainless Steel 1454 012

Accessories Click

Underlay

TARKOMFORT PREMIUM

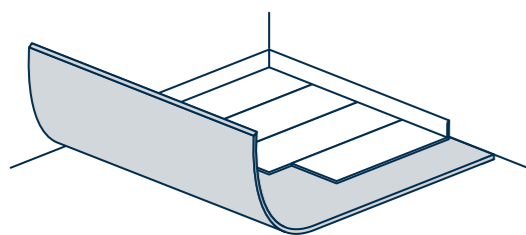

Loose-laid engineered underlayer, made of viscoelastic polymer with double sided anti-slip texture for enhanced acoustic performance.

Size (m): 15 length x 1 width (15lm version)
73 length x 1 width (73lm version)
35 rolls per pallet

● Black 15lm 24992 030 - 73lm 24992 032

MARATHON DUAL

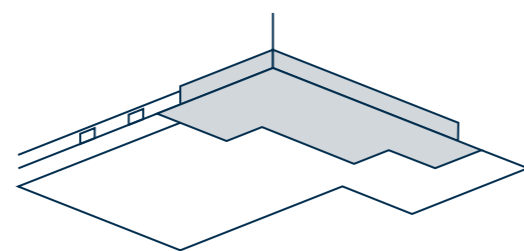

Prefabricated fast-track subfloor preparation system, made of MDF combined with coniferous woods, for easy and effective renovation over the existing subfloor.

Size (m): 0.79 length x 0.56 width
12 bases and 12 top boards (5.31 m²)

● Beige 24993 020

TARKOMFORT PRO

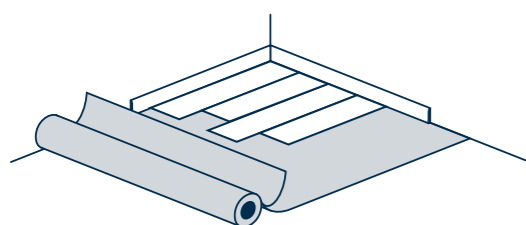

Loose-laid underlayer made of siliconised PET carrier film with high-resistance polyurethane layer and non-woven backing. Specially designed to reduce noise and for floating installation.

Size (m): 10 length x 1 width
40 rolls per pallet

● Grey 2499 2020

Specification model

iD Inspiration Luxury vinyl tiles

The selected LVT flooring similar to iD Inspiration belongs to the compact vinyl floors category under the ISO standard 15081, available in Glue Down and Click versions and in various formats. The product offers a choice of 100 realistic designs available in different construction and wear-layer quality, including digitally print designs in high definition and with no repeat up to 12sqm or 50 planks of 20x120cm.

Ultra matt finish and unequalled resistance for all commercial and residential areas.

The wear layer of 0.30, 0.55 or 0.70 mm is reinforced with the TEKTANIUM treatment, which brings an ultra-matt finish and unequalled resistance to scratch, stains and soiling, as well as easy cleaning for maximum hygiene and resistance to chemicals and staining in sensitive areas. It permanently suppresses any wax and regenerating polish spray maintenance operations. It has a static indentation resistance ≤ 0.10 mm.
10 year warranty.

SUSTAINABILITY CREDENTIALS

Good materials

Made in Europe, the product is manufactured with a phthalate-free plasticiser.

Recycled content

The calandered backing layer is partially made of recycled vinyl. It contains 35% post-production recycled material for the click designs. The glue-down designs contain a minimum of 34% production waste and a minimum of 1.7% post-consumer waste.

Recyclability

The product is recyclable. Installation off-cuts and post-use flooring can be collected through the Tarkett ReStart® programme for the click designs. Installation off-cuts can be collected and recycled for the glue-down designs. The collected waste is recycled and used to reproduce high quality products comparable to the originals.

Optimal indoor Air quality

Its emission rate of volatile organic compounds in air is less than $10 \mu\text{g}/\text{m}^3$, tested 28 days after installation. A threshold 100 times lower than levels set by the most stringent EU regulations.

Material transparency

The selected flooring is covered by a specific third-party verified Environmental Product Declaration (EPD), disclosing several indicators linked to the product's environmental impact. The selected flooring is also covered by a third-party verified ingredient disclosure and material risk declaration down to 0.01%, ensuring compliance far beyond REACH regulation requirements, this Material Health Statement (MHS) is delivered by the Environmental Protection Encouragement Agency (EPEA).

Technical Datasheet Glue-down

	STANDARDS	ID INSPIRATION 30	ID INSPIRATION 55	ID INSPIRATION HIGH TRAFFIC 70	
CERTIFICATION & CLASSIFICATION					
Type of floor covering	EN ISO 10582	Heterogeneous Compact Resilient Floorcovering	Heterogeneous Compact Resilient Floorcovering	Heterogeneous Compact Resilient Floorcovering	
Classification	EN ISO 10874	Domestic: 23 Commercial: 31	Domestic: 23 Commercial: 33 Industrial: 42	Domestic: 23 Commercial: 34 Industrial: 43	
TECHNICAL CHARACTERISTICS					
Total thickness	EN ISO 24346	2 mm	2.5 mm	2.5 mm	
Wear layer thickness	EN ISO 24340	0.30	0.55	0.70	
Total weight	EN ISO 23997	3400 g / m ²	3850 g / m ²	3950 g / m ²	
Wear layer binder content	EN ISO 10582	Type 1	Type 1	Type 1	
Dimensions	EN ISO 24342	Planks 20 x 120 cm, 19 planks/box = 4.56 m ² 28.50 x 120 cm, 13 planks/box = 4.45 m ² 25 x 150 cm, 12 planks/box = 4.50 m ² Tiles 50 x 50 cm, 18 tiles/box = 4.50 m ² 50 x 100 cm, 9 tiles/box = 4.50 m ² 66.66 x 66.66 cm, 10 tiles/box = 4.44 m ² 33.33 x 66.66 cm, 20 tiles/box = 4.44 m ²	Planks 20 x 120 cm, 15 planks/box = 3.60 m ² 28.50 x 120 cm, 11 planks/box = 3.76 m ² 25 x 150 cm, 10 planks/box = 3.75 m ² Tiles 50 x 50 cm, 15 tiles/box = 3.75 m ² 50 x 100 cm, 7 tiles/box = 3.50 m ² 66.66 x 66.66 cm, 8 tiles/box = 3.55 m ² 33.33 x 66.66 cm, 16 tiles/box = 3.55 m ²	Planks 20 x 120 cm, 15 planks/box = 3.60 m ² 28.50 x 120 cm, 11 planks/box = 3.76 m ² 25 x 150 cm, 10 planks/box = 3.75 m ² Tiles 50 x 50 cm, 15 tiles/box = 3.75 m ² 50 x 100 cm, 7 tiles/box = 3.50 m ² 66.66 x 66.66 cm, 8 tiles/box = 3.55 m ² 33.33 x 66.66 cm, 16 tiles/box = 3.55 m ²	Planks 20 x 120 cm, 15 planks/box = 3.60 m ² 28.50 x 120 cm, 11 planks/box = 3.76 m ² 25 x 150 cm, 10 planks/box = 3.75 m ² Tiles 50 x 50 cm, 15 tiles/box = 3.75 m ² 50 x 100 cm, 7 tiles/box = 3.50 m ² 66.66 x 66.66 cm, 8 tiles/box = 3.55 m ² 33.33 x 66.66 cm, 16 tiles/box = 3.55 m ²
Surface treatment (PUR)	-	Yes - Tektanium™	Yes - Tektanium™	Yes - Tektanium™	
Bevelled edges	-	No	Yes	Yes	
High definition Digitally Printed	-	Yes on Naturals references	Yes on Naturals references	Yes on Naturals references	
Embossing in Register	-	Yes on Authentics references	Yes on Authentics references	Yes on Authentics references	
TECHNICAL PERFORMANCES					
Dimensional stability	EN ISO 23999	≤ 0.15%	≤ 0.10%	≤ 0.10%	
Curl resultant to heat	EN ISO 24346	≤ 2 mm	≤ 2 mm	≤ 2 mm	
Reaction to fire	EN 13501-1	B _n -s1 glued over concrete substrate B _n -s1 glued over wood substrate	B _n -s1 glued over concrete substrate B _n -s1 glued over wood substrate	B _n -s1 glued over concrete substrate B _n -s1 glued over wood substrate	
Residual indentation	EN ISO 24343-1	≤ 0.05 mm	≤ 0.05 mm	≤ 0.05 mm	
Furniture leg	EN 424	No damage	No damage	No damage	
Castor chair	ISO 4918- EN 425	No damage	No damage	No damage	
Impact sound reduction	EN ISO 717-2	ΔLw = 3 dB	ΔLw = 3 dB	ΔLw = 3 dB	
Reduction of in-room impact noise	EN ISO 31-074	Class C (L _{n,e,w} < 85 dB)	Class C (L _{n,e,w} < 85 dB)	Class C (L _{n,e,w} < 85 dB)	
Thermal resistance	EN ISO 10456	0.02 m ² K/W	0.02 m ² K/W	0.02 m ² K/W	
Light fastness	EN ISO 105-B02 (method 3a)	≥ 6	≥ 6	≥ 6	
Chemical resistance	EN ISO 26987	Very good	Very good	Very good	
Slip resistance	DIN 51130 EN 13893	R9/R10 depending on embossing μ ≥ 0.30	R9/R10 depending on embossing μ ≥ 0.30	R9/R10 depending on embossing μ ≥ 0.30	
Electrical properties	EN 1815	< 2 kV on concrete	< 2 kV on concrete	< 2 kV on concrete	
Peeling resistance	EN ISO 24345	≥ 50 N / 50 mm	≥ 50 N / 50 mm	≥ 50 N / 50 mm	
Underfloor heating	-	Suitable - max. 27°C	Suitable - max. 27°C	Suitable - max. 27°C	
ENVIRONMENTAL TAG					
VOC emission	ISO 16000-9	≤ 10 μg / m ³ (TVOC after 28 days)	≤ 10 μg / m ³ (TVOC after 28 days)	≤ 10 μg / m ³ (TVOC after 28 days)	
Recycled content	-	38.8% production waste 1.9% post-consumer waste	34.9% production waste 1.7% post-consumer waste	34.7% production waste 1.7% post-consumer waste	
Recyclable	-	Yes - installation waste	Yes - installation waste	Yes - installation waste	
Plasticizer	-	Phthalate-free	Phthalate-free	Phthalate-free	
WARRANTIES					
Commercial warranty		10 years	10 years	10 years	
CE MARKING					
Dop number		0132-0080-DoP-2019-08	0132-0084-DoP-2020-03	0132-0085-DoP-2020-03	

CUSTOMS TARIFF: 4820 5000 00

The above information is subject to modification for the benefit of further improvement. (01/21).

According to the European Regulation N° 305/2011 for CE Marking, the Declarations of Performance are available on our website www.tarkett.com

Tarkett's instructions regarding installation, cleaning and maintenance should be observed. Please contact Tarkett at the address shown for these instructions.



Technical Datasheet Click

	STANDARDS	ID INSPIRATION CLICK SOLID 30	ID INSPIRATION CLICK SOLID 55	ID INSPIRATION CLICK HIGH TRAFFIC 70
CERTIFICATION & CLASSIFICATION				
Type of floor covering	EN ISO 10582	Heterogeneous Compact Resilient Floorcovering	Heterogeneous Compact Resilient Floorcovering	Heterogeneous Compact Resilient Floorcovering
Classification	EN ISO 10874	Domestic: 23 Commercial: 31	Domestic: 23 Commercial: 33 Industrial: 42	Domestic: 23 Commercial: 34 Industrial: 43
TECHNICAL CHARACTERISTICS				
Total thickness	EN ISO 24346	5 mm	5 mm	5 mm
Wear layer thickness	EN ISO 24340	0.30	0.55	0.70
Total weight	EN ISO 23997	8900 g / m ²	8850 g / m ²	8350 g / m ²
Wear layer binder content	EN ISO 10582	Type 1	Type 1	Type 1
Dimensions	EN ISO 24342	Planks 19.70 x 121.70 cm, 7 planks/box = 1.61 m ² 24.70 x 149.70 cm, 5 planks/box = 1.79 m ² Tiles 33.03 x 60.70 cm, 9 tiles/box = 1.75 m ² 49.70 x 99.70 cm, 3 tiles/box = 1.46 m ²	Planks 19.70 x 121.70 cm, 7 planks/box = 1.61 m ² 24.70 x 149.70 cm, 5 planks/box = 1.79 m ² Tiles 33.03 x 60.70 cm, 9 tiles/box = 1.75 m ² 49.70 x 99.70 cm, 3 tiles/box = 1.46 m ²	Planks 19.70 x 121.70 cm, 7 planks/box = 1.61 m ² 24.70 x 149.70 cm, 5 planks/box = 1.79 m ² Tiles 33.03 x 60.70 cm, 9 tiles/box = 1.75 m ² 49.70 x 99.70 cm, 3 tiles/box = 1.46 m ²
Surface treatment (PUR)	-	Yes - Tektanium™	Yes - Tektanium™	Yes - Tektanium™
Bevelled edges	-	Yes	Yes	Yes
Embossing in Register	-	Yes on Authentics references	Yes on Authentics references	Yes on Authentics references
TECHNICAL PERFORMANCES				
Dimensional stability standard value	EN ISO 23999	≤ 0.15%	≤ 0.15%	≤ 0.15%
Dimensional stability average measured value	EN ISO 23999	≤ 0.10%	≤ 0.10%	≤ 0.10%
Curl resultant to heat	EN ISO 23999	≤ 1 mm	≤ 1 mm	≤ 1 mm
Reaction to fire	EN 13501-1	B _n -s1 glued over concrete substrate	B _n -s1 glued over concrete substrate	B _n -s1 glued over concrete substrate
Residual indentation	EN ISO 24343-1	≤ 0.10 mm	≤ 0.10 mm	≤ 0.10 mm
Furniture leg	EN 424	No damage	No damage	No damage
Castor chair	ISO 4918- EN 425	No damage	No damage	No damage
Impact sound reduction	EN ISO 717-2	ΔLw = 5 dB	ΔLw = 5 dB	ΔLw = 5 dB
Reduction of in-room impact noise	EN ISO 31-074	Class C (L _{n,e,w} < 85 dB)	Class C (L _{n,e,w} < 85 dB)	Class C (L _{n,e,w} < 85 dB)
Thermal resistance	EN ISO 10456	0.05 m ² K/W	0.05 m ² K/W	0.05 m ² K/W
Light fastness	EN ISO 105-B02 (method 3a)	≥ 6	≥ 6	≥ 6
Chemical resistance	EN ISO 26987	Very good	Very good	Very good
Slip resistance	DIN 51130 EN 13893	R9/R10 depending on embossing μ ≥ 0.30	R9/R10 depending on embossing μ ≥ 0.30	R9/R10 depending on embossing μ ≥ 0.30
Peeling resistance	EN ISO 24345	≥ 50 N / 50 mm	≥ 50 N / 50 mm	≥ 50 N / 50 mm
Underfloor heating	-	Suitable - max. 27°C	Suitable - max. 27°C	Suitable - max. 27°C
ENVIRONMENTAL TAG				
VOC emission	ISO 16000-9	≤ 10 μg/m ³ (TVOC after 28 days)	≤ 10 μg/m ³ (TVOC after 28 days)	≤ 10 μg/m ³ (TVOC after 28 days)
Recycled content	-	35% production waste	35% production waste	35% production waste
Recyclable	-	yes - installation and post-consumer waste	yes - installation and post-consumer waste	yes - installation and post-consumer waste
Plasticizer	-	Phthalate-free	Phthalate-free	Phthalate-free
WARRANTIES				
Commercial warranty		10 years	10 years	10 years
CE MARKING				
Dop number		0197-0054-DoP-2021-02	0197-0011-DoP-2021-02	0197-0051-DoP-2021-02

CUSTOMS TARIFF: 4820 5000 00

The above information is subject to modification for the benefit of further improvement. (01/21).

According to the European Regulation N° 305/2011 for CE Marking, the Declarations of Performance are available on our website www.tarkett.com

Tarkett's instructions regarding installation, cleaning and maintenance should be observed. Please contact Tarkett at the address shown for these instructions.



Product Details and Skirtings

DECOR	COLOUR	STD FORMAT (cm)	BEVELS	0.30 SAP CODE	0.55 SAP CODE	0.70 SAP CODE	LRV%	SKIRTING
CLASSICS - ROTOGRAVURE								
Rock	Grey	33.33 x 66.66	4V	24532 001	24516 001	24505 001	34.9	26646 001
Vintage Zinc	Silver	33.33 x 66.66	4V	24532 002	24516 002	24505 002	19.02	26646 002
	Black	33.33 x 66.66	4V	24532 003	24516 003	24505 003	8.33	26646 003
Brushed Pine	Brown	20 x 120	4V	Make to order	24513 004	24502 004	22.88	26646 004
	Grey	20 x 120	4V	Make to order	24513 005	24502 005	29.78	26646 005
Antik Oak	Dark Grey	20 x 120	4V	24524 006	24513 006	24502 006	25.48	26646 006
	Beige	20 x 120	4V	24524 007	24513 007	24502 007	32.26	26646 007
	Natural	20 x 120	4V	Make to order	24513 028	24502 028	28.17	26646 008
English Oak	Classical	20 x 120	4V	24524 008	24513 008	24502 008	26.43	26646 009
	Brown	20 x 120	4V	24524 009	24513 009	24502 009	18.07	26646 010
	Natural	20 x 120	4V	24524 010	24513 010	24502 010	23.38	26646 011
	Grey-Beige	20 x 120	4V	24524 011	24513 011	24502 011	34.81	26646 012
	Grege	20 x 120	4V	24524 012	24513 012	24502 012	33.09	26646 013
Composite	Cool Grey	50 x 100	0V	24533 013	24522 013	24511 013	29.57	26646 014
Scandinavian Oak	Medium Grey	20 x 120	4V	24524 014	24513 014	24502 014	44.45	26646 015
	Dark Grey	20 x 120	4V	24524 015	24513 015	24502 015	24.46	26646 016
	Medium Beige	20 x 120	4V	24524 016	24513 016	24502 016	41.36	26646 017
Patina Ash	Grey	20 x 120	4V	Make to order	24513 017	24502 017	32.2	26646 018
	Brown	20 x 120	4V	Make to order	24513 018	24502 018	31.54	26646 019
Contemporary Oak	Natural	20 x 120	4V	24524 019	24513 019	24502 019	29.65	26646 020
	Grege	20 x 120	4V	24524 020	24513 020	24502 020	30.47	26646 021
	Grey	20 x 120	4V	24524 021	24513 021	24502 021	29.09	26646 022
Oxide	Copper	33.33 x 66.66	4V	Make to order	24516 022	24505 022	13.07	26646 023
	Steel	33.33 x 66.66	4V	Make to order	24516 023	24505 023	18.33	26646 024
	Black Steel	33.33 x 66.66	4V	Make to order	24516 024	24505 024	14.14	26646 025
Rustic Oak	Beige	20 x 120	4V	24524 025	24513 025	24502 025	31.64	26646 026
	Light Grey	20 x 120	4V	24524 026	24513 026	24502 026	46.56	26646 027
	Warm Natural	20 x 120	4V	24524 027	24513 027	24502 027	27.52	26646 028
AUTHENTICS - EMBOSSING IN REGISTER								
Highland Oak	Arabica	20 x 120	4V	Make to order	24513 088	24502 088	10.45	26646 088
	Cream	20 x 120	4V	Make to order	24513 087	24502 087	40.67	26646 087
	Golden	20 x 120	4V	Make to order	24513 091	24502 091	29.38	26646 091
	Noisette	20 x 120	4V	Make to order	24513 090	24502 090	22.86	26646 090
	Smoke	20 x 120	4V	Make to order	24513 089	24502 089	25.98	26646 089
Delicate Oak	Sugar	20 x 120	4V	Make to order	24513 096	24502 096	51.05	26646 096
	Barley	20 x 120	4V	Make to order	24513 094	24502 094	31.04	26646 094
	Clay	20 x 120	4V	Make to order	24513 095	24502 095	25.66	26646 095
	Almond	20 x 120	4V	Make to order	24513 092	24502 092	34.28	26646 092
	Toffee	20 x 120	4V	Make to order	24513 093	24502 093	20.43	26646 093
Pearl Oak	Candis	20 x 120	4V	Make to order	24513 100	24502 100	30.56	26646 100
	Dune	20 x 120	4V	Make to order	24513 097	24502 097	42.39	26646 097
	Latte	20 x 120	4V	Make to order	24513 099	24502 099	41.93	26646 099
	Pekan	20 x 120	4V	Make to order	24513 098	24502 098	15.20	26646 098
NATURALS - DIGITAL PRINTING								
Forest Oak	Nutmeg	20 x 120	4V	24524029	24513 029	24502 029	34.2	26646 029
	Pistaccio Shell	20 x 120	4V	24524030	24513 030	24502 030	46.37	26646 030
	Natural	20 x 120	4V	24524031	24513 031	24502 031	37.83	26646 031
Belgian Stone	Dune	50 x 100	0V	24533036	24522 036	24511 036	44.01	26646 036
	Loam	50 x 100	0V	24533035	24522 035	24511 035	18.4	26646 035
	Silt	50 x 100	0V	24533037	24522 037	24511 037	27.88	26646 037
Patina Concrete	Light Grey	50 x 100	0V	Make to order	24522 032	24511 032	32.76	26646 032
	Medium Grey	50 x 100	0V	Make to order	24522 033	24511 033	22.97	26646 033
	Dark Grey	50 x 100	0V	Make to order	24522 034	24511 034	17.3	26646 034

Glue-down

DECOR	COLOUR	STD FORMAT (cm)	BEVELS	0.30 SAP CODE	0.55 SAP CODE	0.70 SAP CODE	LRV%	SKIRTING
NATURALS - DIGITAL PRINTING								
Creek Oak	Beige	20 x 120	4V	Make to order	24513 041	24502 041	22.3	26646 041
	Brown	20 x 120	4V	Make to order	24513 043	24502 043	13.07	26646 043
	Natural	20 x 120	4V	Make to order	245130 42	24502 042	26.1	26646042
Moonstone	Darkblue	50 x 50	4V	Make to order	24518 078	24507 078	8.32	26646 078
Century	Dawn	66.66 x 66.66	0V	Make to order	24523 059	24512 059	40.7	26646 059
Travertin Grande	Sand	50 x 100	4V	Make to order	24517 082	24506 082	55.9	26646 082
Cast Concrete	Cement	50 x 100	0V	Make to order	24522 058	24511 058	37.43	26646 058
Nomad Oak	Coffee	28.50 x 120	4V	24526 072	24515 072	24504 072	11.7	26646 072
	Hazel	28.50 x 120	4V	24526 071	24515 071	245040 71	18.07	26646 071
	Linen	28.50 x 120	4V	24526 069	24515 069	24504 069	41.58	26646 069
	Oat	28.50 x 120	4V	24526 070	24515 070	24504 070	21.04	26646 070
Douglas Pine	Creme	25 x 150	4V	24525 045	24514 045	24503 045	40	26646 045
	Soaped	25 x 150	4V	24525 046	24514 046	24503 046	50.58	26646 046
Variant Oak	Beige	20 x 120	4V	Make to order	24513 038	24502 038	36.73	26646 038
	Light Grey	20 x 120	4V	Make to order	24513 039	24502 039	32.93	26646 039
	Natural	20 x 120	4V	Make to order	24513 040	24502 040	37.68	26646 040
Chatillon Oak	Natural	25 x 150	4V	24525 060	24514 060	24503 060	43.01	26646 060
	Brown	25 x 150	4V	24525 061	24514 061	24503 061	22.91	26646 061
	Beige	25 x 150	4V	24525 062	24514 062	24503 062	29.67	26646 062
Wagon Board	Floated	25 x 150	4V	Make to order	24514 081	24503 081	28.41	26646 081
Swiss Oak	Natural	28.50 x 120	4V	24526 075	24515 075	24504 075	29.93	26646 075
	Smoked	28.50 x 120	4V	24526 076	24515 076	24504 076	22.72	26646 076
	Stained	28.50 x 120	4V	24526 077	24515 077	24504 077	23.31	26646 077
Classic Pine	Natural	20 x 120	4V	24524 065	24513 065	24502 065	34.53	26646 065
	Sunburned	20 x 120	4V	24524 066	24513 066	24502 066	26.38	26646 066
Charred Wood	Black	20 x 120	4V	24524 053	24513 053	24502 053	9.28	26646 053
Fibra	Natural	50 x 100	0V	Make to order	24522 083	24511 083	39.74	26646 083
	Terracotta	50 x 100	0V	Make to order	24522 084	24511 084	26.88	26646 084
	Black	50 x 100	0V	Make to order	24522 085	24511 085	12.35	26646 085
	Green	50 x 100	0V	Make to order	24522 086	24511 086	27.86	26646 086
	Liguria Slate	Black	50 x 50	4V	24529 067	24518 067	24507 067	6.86
Sediment	Beige	66.66 x 66.66	0V	Make to order	24523 073	24512 073	32.25	26646 073
	Grey	66.66 x 66.66	0V	Make to order	24523 074	24512 074	32.18	26646 074
Marquina Grande	Black	50 x 100	0V	Make to order	24522 068	24511 068	6.5	26646 068
Carrara Grande	White	50 x 100	0V	24533 044	24522 044	24511 044	64.25	26646 044
Emperador	Grey	50 x 100	0V	Make to order	24522 047	24511 047	41.3	26646 047
	Beige	50 x 100	0V	Make to order	24522 048	24511 048	36.35	26646 048
	Green	50 x 100	0V	Make to order	24522 049	24511 049	44.47	26646 049
Terrazzo Classical	Nero	33.33 x 66.66	0V	24532 079	24521 079	24510 079	56.87	26646 079
	Terracotta	33.33 x 66.66	0V	Make to order	24521 080	24510 080	63.23	26646 080
Breccia	Grey	50 x 100	0V	Make to order	24522 052	24511 052	36.05	26646 052
American Walnut	Cinnamon	20 x 120	4V	Make to order	24513 051	24502 051	17.46	26646 051
	Marron	20 x 120	4V	Make to order	24513 050	24502 050	10.7	26646 050
Chestnut	Smoked	25 x 150	4V	24525 063	24514 063	24503 063	11.54	26646 063
	Original	25 x 150	4V	24525 064	24514 064	24503 064	29.73	26646 064
Brushed Elm	Natural	28.50 x 120	4V	24526 054	24515 054	24504 054	37.22	26646 054
	Grege	28.50 x 120	4V	24526 055	24515 055	24504 055	38.62	26646 055
	Beige	28.50 x 120	4V	24526 056	24515 056	24504 056	46.68	26646 056
	Brown	28.50 x 120	4V	24526 057	24515 057	24504 057	36.42	26646 057

Make to order decors shown in this chart are available with MOQ of 500m² for 0.30 wear layers. All 0.55/0.70 designs are on stock.

Product Details and Skirtings

Click

DECOR	COLOUR	STD FORMAT (cm)	BEVELS	0.30 SAP CODE	0.55 SAP CODE	0.70 SAP CODE	LRV%	SKIRTING
CLASSICS - ROTOGRAVURE								
Rock	Grey	33.03 x 60.70	4V	24630 001	24619 001	-	34.9	26646 001
Vintage Zinc	Silver	33.03 x 60.70	4V	24630 002	24619 002	-	19.02	26646 002
	Black	33.03 x 60.70	4V	24630 003	24619 003	-	8.33	26646 003
Brushed Pine	Brown	19.70 x 121.70	4V	24627 004	24616 004	-	22.88	26646 004
	Grey	19.70 x 121.70	4V	24627 005	24616 005	-	29.78	26646 005
Antik Oak	Dark Grey	19.70 x 121.70	4V	24627 006	24616 006	-	25.48	26646 006
	Beige	19.70 x 121.70	4V	24627 007	24616 007	-	32.26	26646 007
	Natural	19.70 x 121.70	4V	24627028	24616028	-	28.17	26646 008
English Oak	Classical	19.70 x 121.70	4V	24627 008	24616 008	24605 008	26.43	26646 009
	Brown	19.70 x 121.70	4V	24627 009	24616 009	-	18.07	26646 010
	Natural	19.70 x 121.70	4V	24627 010	24616 010	24605 010	23.38	26646 011
	Grey-Beige	19.70 x 121.70	4V	24627 011	24616 011	-	34.81	26646 012
	Grege	19.70 x 121.70	4V	24627 012	24616 012	-	33.09	26646 013
Composite	Cool Grey	49.70 x 99.70	0V	24632 013	24625 013	24614 013	29.57	26646 014
Scandinavian Oak	Medium Grey	19.70 x 121.70	4V	24627 014	24616 014	-	44.45	26646 015
	Dark Grey	19.70 x 121.70	4V	24627 015	24616 015	-	24.46	26646 016
	Medium Beige	19.70 x 121.70	4V	24627 016	24616 016	-	41.36	26646 017
Patina Ash	Grey	19.70 x 121.70	4V	24627 017	24616 017	24605 017	32.2	26646 018
	Brown	19.70 x 121.70	4V	24627 018	24616 018	-	31.54	26646 019
Contemporary Oak	Natural	24.70 x 149.70	4V	24628 019	24617 019	24606 019	29.65	26646 020
	Grege	24.70 x 149.70	4V	24628 020	24617 020	24606 020	30.47	26646 021
	Grey	24.70 x 149.70	4V	24628 021	24617 021	24606 021	29.09	26646 022
Oxide	Copper	33.03 x 60.70	4V	24630 022	24619 022	-	13.07	26646 023
	Steel	33.03 x 60.70	4V	24630 023	24619 023	24608 023	18.33	26646 024
	Black Steel	33.03 x 60.70	4V	24630 024	24619 024	-	14.14	26646 025
Rustic Oak	Beige	19.70 x 121.70	4V	24627 025	24616 025	-	31.64	26646 026
	Light Grey	19.70 x 121.70	4V	24627 026	24616 026	-	46.56	26646 027
	Warm Natural	19.70 x 121.70	4V	24627 027	24616 027	-	27.52	26646 028
AUTHENTICS - EMBOSSING IN REGISTER								
Highland Oak	Arabica	19.70 x 121.70	4V	24627 088	24616 088	-	10.45	26646 088
	Cream	19.70 x 121.70	4V	24627 087	24616 087	24605 087	40.67	26646 087
	Golden	19.70 x 121.70	4V	24627 091	24616 091	-	29.38	26646 091
	Noisette	19.70 x 121.70	4V	24627 090	24616 090	-	22.86	26646 090
	Smoke	19.70 x 121.70	4V	24627 089	24616 089	24605 089	25.98	26646 089
Delicate Oak	Sugar	19.70 x 121.70	4V	24627 096	24616 096	-	51.05	26646 096
	Barley	19.70 x 121.70	4V	24627 094	24616 094	-	31.04	26646 094
	Clay	19.70 x 121.70	4V	24627 095	24616 095	-	25.66	26646 095
	Almond	19.70 x 121.70	4V	24627 092	24616 092	-	34.28	26646 092
	Toffee	19.70 x 121.70	4V	24627 093	24616 093	-	20.43	26646 093
Pearl Oak	Candis	19.70 x 121.70	4V	24627 100	24616 100	-	30.56	26646 100
	Dune	19.70 x 121.70	4V	24627 097	24616 097	-	42.39	26646 097
	Latte	19.70 x 121.70	4V	24627 099	24616 099	-	41.93	26646 099
	Pekan	19.70 x 121.70	4V	24627 098	24616 098	-	15.20	26646 098

Click installation is only available for Authentics and Classics.

Naturals decors will be available in click by end of 2021 with a selection of decors in permanent stock.

Naturals decors not available on stock in 0.30/0.55 click can be made to order with MOQ of 600m².

The designs and photos used in this brochure
are for illustration purposes only.
They are not contractual images and do not
stand for product or installation recommendation.



■ **WESTERN EUROPE:** Austria: Tarkett Holding GmbH, Niederlassung Wien – Tel. +43 1 47 88 062 ■ Belgium: Tarkett Belux Sprl – Tel. +32 52 26 24 11 ■ Denmark: Tarkett A/S – Tel. +45 43 90 60 11 ■ Finland: Tarkett Oy – Tel. +358 9 4257 9000 ■ France: Tarkett SAS – Tel. +33 1 41 20 42 49 ■ Germany: Tarkett Holding GmbH – Tel. +49 621 68172 300 ■ Greece: Tarkett Monoprosopi Ltd – Tel. +30 210 6745 340 ■ Italy: Tarkett S.p.A. – Tel. +39 0744 7551 ■ Luxembourg: Tarkett GDL SA – Tel. +352 949 211 8804 ■ Netherlands: Tarkett BV – Tel. +31 416 685 491 ■ Norway: Tarkett AS – Tel. +47 32 20 92 00 ■ Portugal: Tarkett SA – Tel. +351 21 427 64 20 ■ Spain: Tarkett Floors S.L. – Tel. +34 91 359 00 35 ■ Sweden: Tarkett Sverige AB – Tel. +46 771 25 19 00 ■ Switzerland: Tarkett Holding GmbH – Tel. +41 043 233 79 24 ■ Turkey: Tarkett Aspen – Tel. +90 212 213 65 80 ■ United Kingdom: Tarkett Ltd – Tel. +44 (0) 1622 854 040 ■ **EASTERN EUROPE:** Baltic Countries: Tarkett Baltics: Tel. +370 37 262 220 ■ Czech Republic: Tarkett org. slozka – Tel. +420 271 001 600 ■ Hungary: Tarkett Polska SP Z.O.O. magyarországi fióktelepe – Tel. +36 1 437 8150 ■ Poland: Tarkett Polska Sp. z o. o. – Tel. +48 22 16 09 231 ■ Russian Federation: ZAO Tarkett RUS – Tel. +7 495 775 3737 ■ Slovakia: Tarkett Polska, organizačná zložka – Tel. +421 2 48291 317 ■ **South East Europe:** Tarkett SEE – Tel. +381 21 7557 649 (44) 569 12 21 ■ Ukraine: Tarkett UA – Tel. +38 (0) 44 35 45 621 ■ **ASIA AND OCEANIA:** Australia: Tarkett Australia Pty Ltd – Tel. +61 2 88 53 12 00 ■ China: Tarkett Floor Covering (Shanghai) Co. Ltd. – Tel. +86 (21) 60 95 68 38 ext 841 ■ North East Asia: Tarkett Hong Kong Limited – Tel. +852 2511 8716 ■ India: Tarkett Flooring India Pvt. Ltd. – Bangalore - Tel. +91 80 4130 3793 – New Delhi - Tel. +91 11 4352 4073 – Mumbai - Tel. +91 22 2648 8750 ■ South East Asia: Tarkett Flooring Singapore Pte. Ltd. – Tel. +65 6346 1585 ■ **AFRICA:** Tarkett International: Tel. +33 1 41 20 41 01 ■ **MIDDLE EAST:** Tarkett Middle East: Tel. +961 1 51 3363/4 ■ Israel: Tarkett International: Tel. +33 1 41 20 41 01 ■ **NORTH AMERICA:** USA: Tarkett Inc. – Tel. +1 713 869 5811 / Johnsonite – Tel. +1 440 543 8916 ■ Canada: Tarkett Inc. – Tel. +1 450 293 173 ■ **LATIN AMERICA:** Brazil: Tarkett – Tel. 55 12 3954 7108 ■ Argentina - Chile - Uruguay: Tarkett Latam Mercosur - Tel. +54 11 47 08 07 72 / +54 9 11 44 46 88 82 ■ Bolivia - Colombia - Ecuador - Panama - Paraguay - Peru - Trinidad and Tobago - Venezuela: Tarkett - Tel. +55 11 9 8410 9310 / +55 11 95494 0069 ■ Mexico /Central America: Tarkett Latam Mexico - Tel. +55 11 98410 9310

The designs and photos used in this brochure are for illustration purposes only.
They are not contractual images and do not stand for product or installation recommendation.
Design: Studio 5•5 / Photos: Studio 5•5

professionals.tarkett.com



 **Tarkett**